



SL-SNFT2-8-SC

Flat Track Sliding Door Hardware — Side Mount Hanger

PRODUCT CUT SHEET

PROJECT:
SUBMITTED BY:
DATE:
NOTES:

Flat Track System — Track Length 96"

- Fits 1 $\frac{3}{8}$ " to 1 $\frac{3}{4}$ " Thick Door Panel
- Satin Nickel Electroplated Steel
- Side Wall Mounted Track
- Nylon Wheels for Smooth Operation
- For Sliding Doors up to 176 lbs. Each
- Meets ADA Push Force Requirements
- 5-Year Warranty
- Order Two Sets for Bi-Parting Applications
- Soft Close / Open Hardware is Included for Both Directions in Addition to the SL-SNFT2-8-SC Complete Kit Contents

Complete Kits Include:

- | | |
|------------------------|-----------------|
| (1) Track | (2) Door Stops |
| (2) Soft Close Devices | (1) Floor Guide |
| (2) Hangers | |

SL-SNFT2-8-SC includes:
(6) Wall Attachments

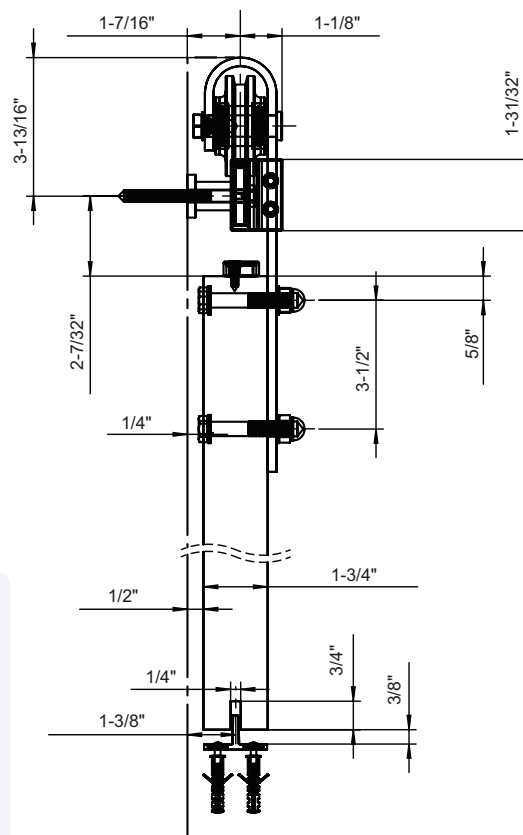

NGP-SLI-SL-SNFT2-8-SC-PCS-0324-A

NATIONAL GUARD PRODUCTS, INC.

MEMPHIS

4985 East Raines Road
Memphis, TN 38118

CARSON CITY

3689 Arrowhead Drive
Carson City, NV 89706

Fax: (800) 255-7874

Email: info@ngp.com

Quotes: quotes@ngp.com

Orders: orders@ngp.com

ngp.com
1-800-NGP-RUSH