

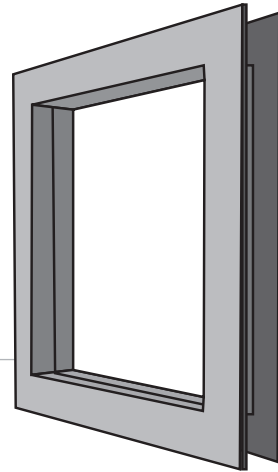

L-GLF100-SP

Square Profile Lite Kit

PRODUCT CUT SHEET



PROJECT:

SUBMITTED BY:

DATE:

NOTES:

For Variable Door and/or Glass Thickness

- 18 Ga. Cold Rolled Steel
- Mitered and Welded Corners
- Welded Reinforcing Clips at Corners
- Counter-Sunk Mounting Screw-Holes
- #6 Phillips Truss Head SMS
- Gray Primer (GPZ) Powder Coat Finish

Required Information

- Specify Glass Thickness on Order
- Specify Door Thickness on Order if Other Than 1 3/4"

Available Options

- Powder Coat Color Options - See Color Chart on www.ngp.com
- False Mullion Bars
- Torx Security Screws
- Galvanneal - A40 Steel
- Zinc Electro-Plating
- Glass & Glazing Tape
- Lead Lining - .030" Thick

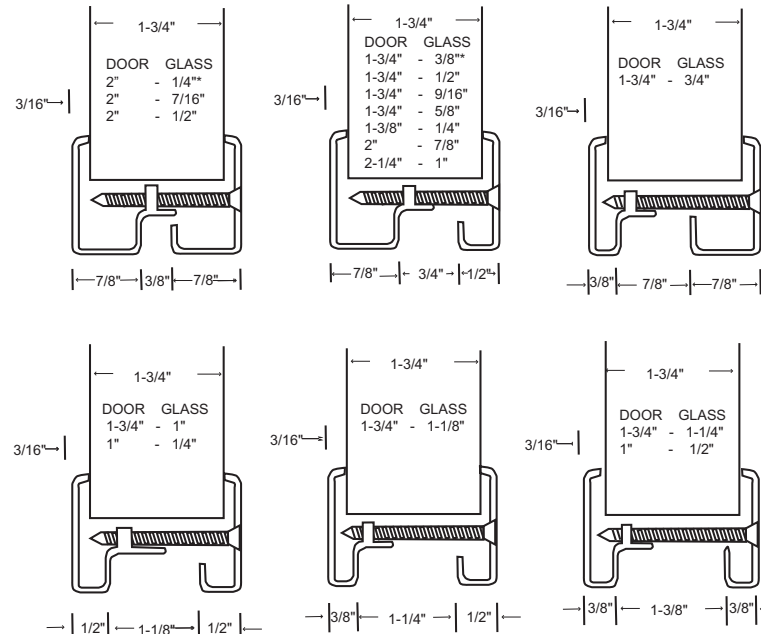

Details shown are for 1 3/4" door thickness
 Only Configurations shown are available
 *Requires the use of GT-316 Glazing tape
 Thru-bolts available for 1 3/4" thick doors only

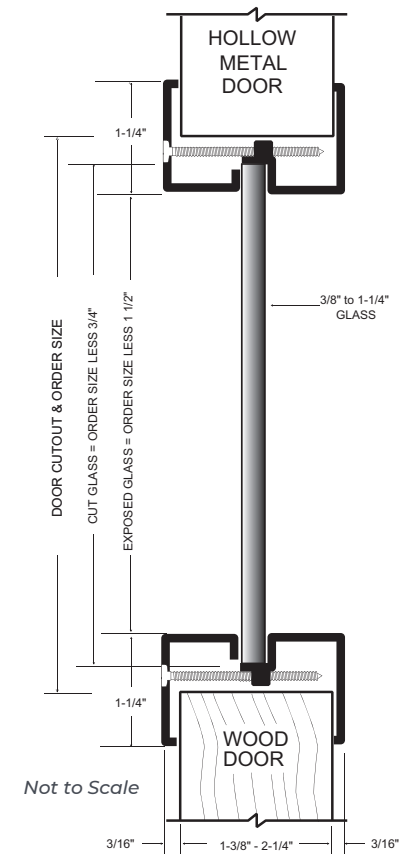

NGP-LIT-L-GLF100-SP-PCS-1221-C



G2 thru G24

False Mullion Lite Kits

PRODUCT CUT SHEET

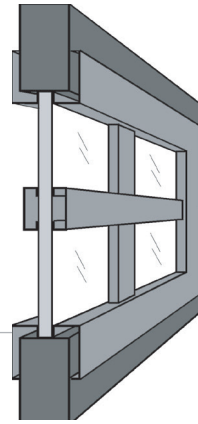

PROJECT:

SUBMITTED BY:

DATE:

NOTES:

Material & Finish

- ▶ 1" Wide Steel Channel
- ▶ Fits L-GLF100, L-GLF100-SP, L-GLF100-TB, L-GLF100-SP-TB, L-SG100, L-SG100-TB
- ▶ Mullion Bars Welded Into Both Sides of Lite Kit
- ▶ Finished to Match Lite Kit

Available Options

- ▶ Zinc Electro-Plating

To Order

Specify Lite Kit x G#

(i.e.: G2, G3, G4 etc.)

If Other Than as Illustrated,
Provide Detail & Suffix G-SP

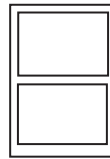

G2
(1 Bar)



G3
(2 Bars)

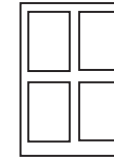

G4
(2 Bars)

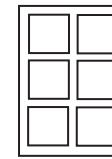

G6
(3 Bars)

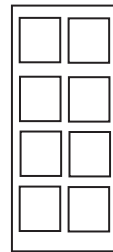

G8
(4 Bars)

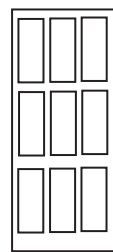

G9
(4 Bars)

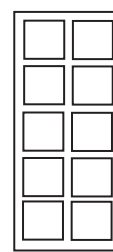

G10
(5 Bars)

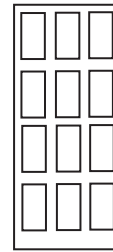

G12
(5 Bars)

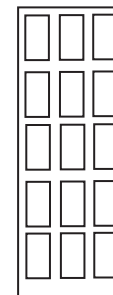

G15
(6 Bars)

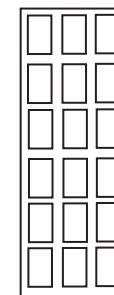

G18
(7 Bars)

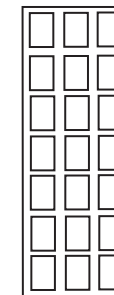

G21
(8 Bars)

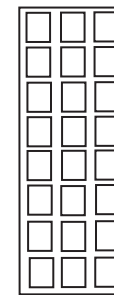

G24
(9 Bars)



NGP-LIT-G2-PCS-1220-A