

# FLOOR CLOSER THRESHOLDS

Thresholds Can Be Fabricated for Use With Any Floor Closer. They Are Available in Aluminum, Bronze, or Stainless Steel in Several Finishes Including SIA Slip-Resistant Finish.

## Specify When Ordering

- ▶ Type x Number (i.e., Type 3 X 427E)
- ▶ Material and Finish
- ▶ Door Opening Width
- ▶ Door Thickness if Other Than 1 3/4"
- ▶ Handing (Door Handing)
- ▶ Closer Manufacturer
- ▶ Closer Model Number

## TYPE 1, 3 & 4 ALUMINUM

|            |      |
|------------|------|
| 1/2" x 7"  | 427E |
| 1/2" x 8"  | 428E |
| 3/4" x 7"  | 713  |
| 3/4" x 8"  | 813  |
| 1/2" x 9"  | 429E |
| 1/2" x 10" | 430E |
| 3/4" x 9"  | 913  |
| 3/4" x 10" | 1013 |

## TYPE 5 ALUMINUM

|                |             |
|----------------|-------------|
| 1/2" x 7" x 4" | 427E x 424E |
| 3/4" x 7" x 4" | 713 x 413   |
| 1/2" x 8" x 5" | 428E x 425E |
| 3/4" x 8" x 5" | 813 x 513   |

## ARCHITECTURAL BRONZE

|           |       |
|-----------|-------|
| 1/2" x 7" | 427BR |
| 1/2" x 8" | 428BR |
| 3/4" x 7" | 713BR |
| 3/4" x 8" | 813BR |

## ARCHITECTURAL BRONZE

|                |               |
|----------------|---------------|
| 1/2" x 7" x 4" | 427BR x 424BR |
| 1/2" x 8" x 5" | 428BR x 425BR |
| 3/4" x 8" x 5" | 813BR x 513BR |

Other Thresholds and Custom Assemblies May Be Prepped for Floor Closers. Consult Factory for Custom Applications.

## Special Finishes Available

- ▶ Polished, Suffix "POL"
- ▶ Dark Oxidized Bronze US10B, Suffix "DKB"
- ▶ SIA Slip-Resistant Finish, Suffix "SIA"



## OFFSET HUNG

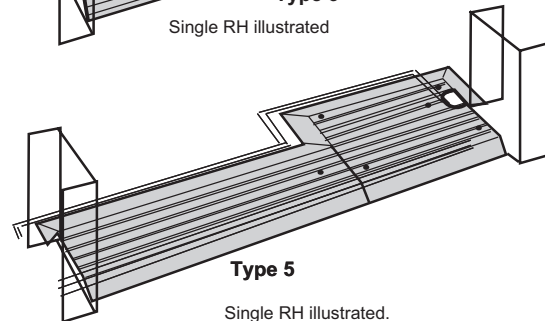
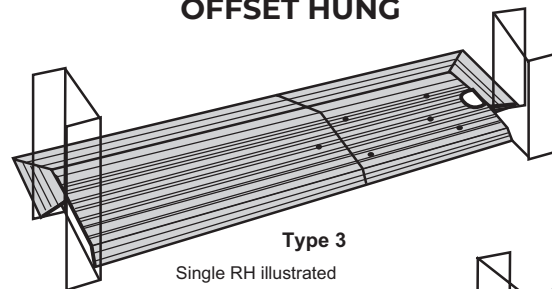

## CENTER HUNG

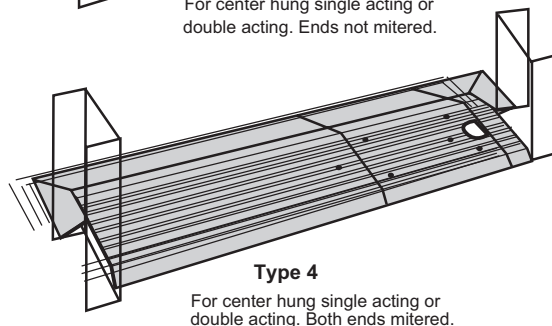
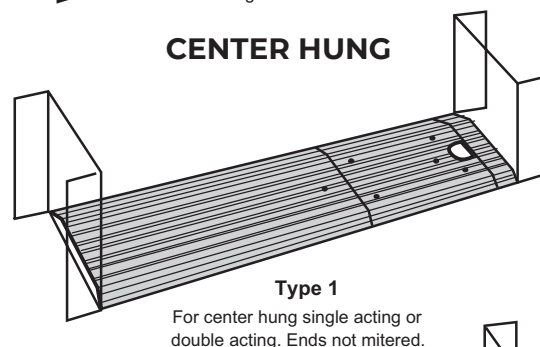

## Stainless Steel Available

- ▶ Specify Type (1, 3 or 4) x Stainless Steel Threshold Model Number

## MATERIALS & FINISHES

#304 Stainless Steel, Mill Finish

### Optional Finishes

- POL - Polished US32, 629
- BRUSHED - Brushed US32D, 630

# FLOOR CLOSER THRESHOLDS

All Products On This Page



## MATERIALS & FINISHES

- Mill Aluminum
- DKB - Aluminum Dark Bronze

## OPTIONAL SIA SLIP-RESISTANT FINISH

For Use in Areas Where Conditions Can Be Hazardous and Safety Is a Priority.

## FASTENERS

- #10 x 1-1/2" FH Zinc-Plated Wood Screws Furnished. Dark Bronze Supplied With DKB.

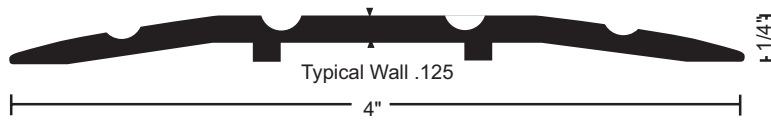

**413** .53 lbs./ft.  
**413DKB** .53 lbs./ft.

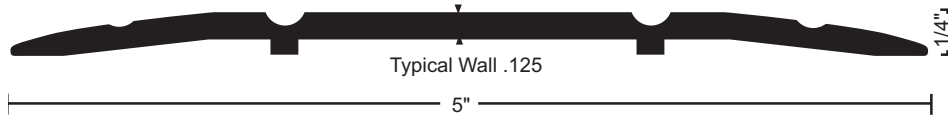

**513** .68 lbs./ft.  
**513DKB** .68 lbs./ft.



**713** 1.01 lbs./ft.  
**713DKB** 1.01 lbs./ft.

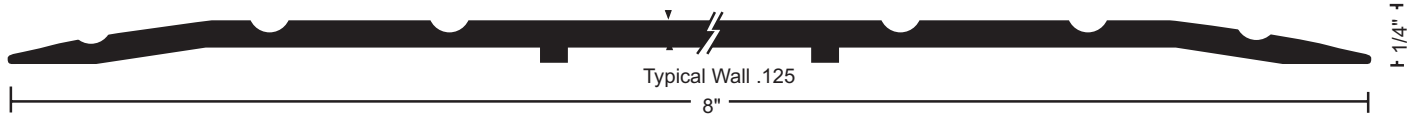

**813** 1.20 lbs./ft.  
**813DKB** 1.20 lbs./ft.



**424E** .60 lbs./ft.  
**424EDKB** .60 lbs./ft.

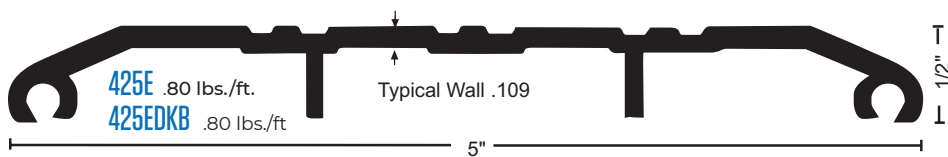

**425E** .80 lbs./ft.  
**425EDKB** .80 lbs./ft.

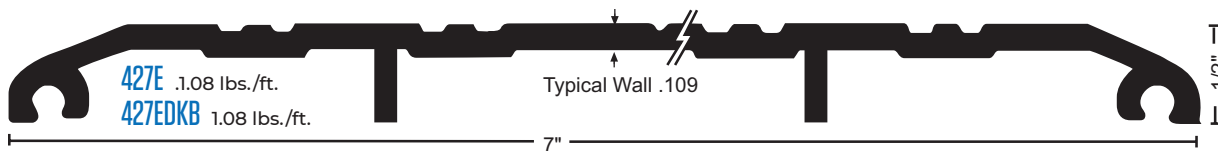

**427E** 1.08 lbs./ft.  
**427EDKB** 1.08 lbs./ft.

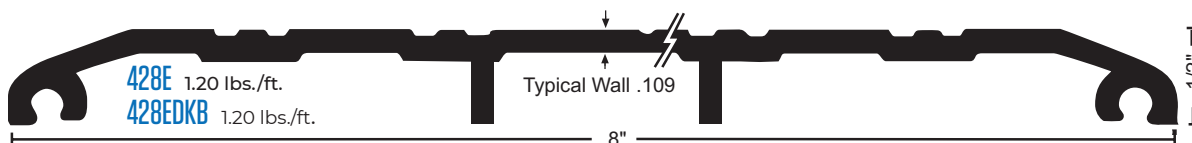

**428E** 1.20 lbs./ft.  
**428EDKB** 1.20 lbs./ft.