

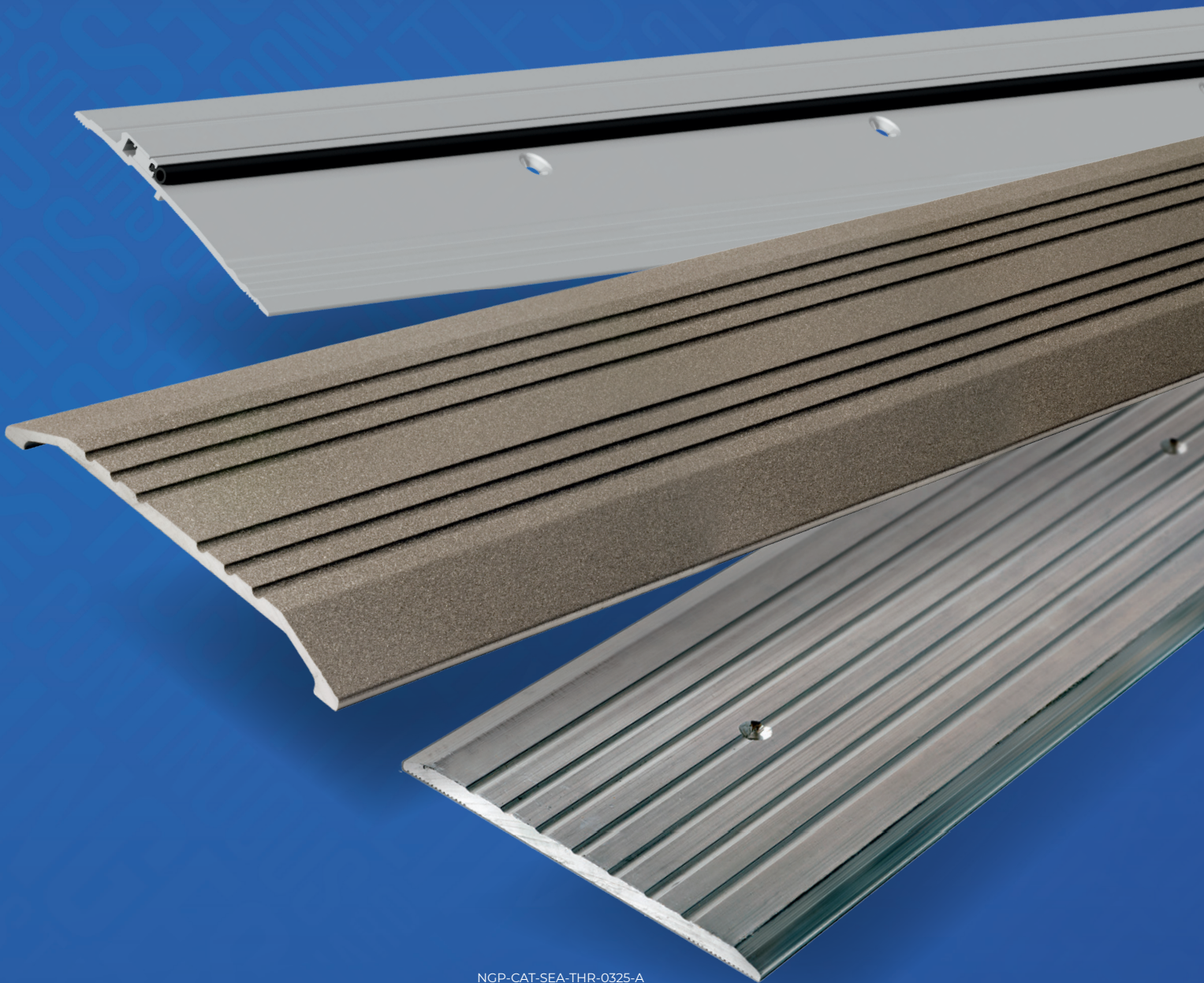

# SEALS

THRESHOLDS





## THRESHOLDS INDEX

---

### Aluminum

Bar Supports. . . . .	T39
Bumper Seal. . . . .	T14, T16-T19, T24-T25, T29-T31
Components	
Half Saddle and Extended Width . . . . .	T23, T25
Transition Strips . . . . .	T23
Cover Plates . . . . .	T40
Custom Fabricated . . . . .	T38
Divider Thresholds and Edges	
Carpet and Tile Dividers,	
Carpet Edges . . . . .	T20
Communicating Door. . . . .	T22
Vinyl Carpet and Tile . . . . .	T21
Edge Components. . . . .	T39
Elevators . . . . .	T31
Extended Width . . . . .	T11-T12, T26
Extended Width Bumper Seal . . . . .	T31
Floor Closer . . . . .	T41-T42
Half Saddle. . . . .	T24-T25
Heavy-Duty . . . . .	T14-T15
Offset . . . . .	T20
Return Closed Ends . . . . .	T34, T36
Ramps	
Aluminum . . . . .	T32
Interlocking . . . . .	T33-T34
Interlocking Offset. . . . .	T35-T36
Interlocking Ramp Components . . . . .	T37
Interlocking Rubber. . . . .	T32
Saddle . . . . .	T7-T10
Smooth Surface. . . . .	T13
Stop Strips . . . . .	T17
Thermal Break	
Saddle. . . . .	T27-T29
Bumper Seal. . . . .	T29-T30
Vinyl Top . . . . .	T31

### Architectural Bronze

Bar Supports. . . . .	T51
Custom Fabricated . . . . .	T51
Floor Closer . . . . .	T41
Half Saddle. . . . .	T49
Interlocking . . . . .	T50
Return Closed Ends . . . . .	T34, T36
Saddle. . . . .	T46-T47
Thermal Break . . . . .	T48

### Stainless Steel

Bumper Seal. . . . .	T45
Cover Plates . . . . .	T40, T45
Floor Closer . . . . .	T41
Saddle. . . . .	T43-T44

### Fasteners. . . . .

Fasteners. . . . .	T52
--------------------	-----

# NUMERICAL INDEX

BAR1	T39	325HDX325HD	T15	434	T10	890	T19	8164	T38
BAR1BR	T51	Welded		435	T10	896	T17	8167	T38
BAR2	T39	327	T25	436	T10	896-ADJ	T16	8168N	T38
BAR2BR	T51	327BR	T49	437	T10	896HD	T14	8170	T38
2	T17	350	T25	438	T10	896SS	T45	8213	T11, T29
BAR4	T39	350BR	T49	439	T10	897	T18	WA8213	T11
4	T17	355	T25	440	T10	898	T24	8413	T28
BAR6SS	T40, T45	398	T21	442BR	T50	912SS	T44	8423	T29
Fasteners	T52	399	T21	457	T23	913	T9	8424	T27
RCE-9	T34, T36	400	T21	458	T23	913SS	T43	8425	T27
12V	T31	401	T21	484BR	T50	950	T17	8426	T27
RCE-15	T34, T36	402	T21	512	T13	951	T37	8427	T27
RCE-21	T34, T36	402X400X	T22	512SS	T44	RR952	T32	8428	T27
RCE-30	T34, T36	400X402		513	T9, T42	953	T37	8428BR	T48
RR42	T32	402X400X	T22	513BR	T46	954	T37	8429	T27
R50	T33, T37	402		513HD	T14	955	T37	8429BR	T48
RO50	T35	404	T20	513SS	T43	957	T37	8430	T27
58	T31	407	T21	515	T23	959	T37	8430BR	T48
R75	T33	410	T13	612SS	T44	960	T37	8433	T29
RO75	T35	411	T13	613	T9	961	T37	8434	T30
80B	T50	412	T13	613BR	T46	962	T37	8435	T30
R100	T33	412SS	T44	613HD	T15	1012SS	T44	8436	T30
RO100	T35	413	T9, T42	613SS	T43	1013	T9	8437	T30
111	T13	413SS	T43	653	T20	1013SS	T43	8475	T8
R125	T33	414	T20	654	T32	RR5007BL	T21, T32	8513	T28
RO125	T35	415	T23	655	T20	8013	T28	8533	T29
R150	T33	415BR	T49	657	T32	8113	T11, T29	8613	T28
RO150	T35	416	T20	659	T20	WA8113	T11	8633	T29
R175	T33	417	T20	700E	T17, T23	8130	T23	8713	T28
RO175	T35	424	T8	712SS	T44	8132	T23	8813	T28
R200	T33	424BR	T47	713	T9, T42	8133	T39	8913	T28
RO200	T35	424E	T7, T42	713BR	T46	8134	T39		
211	T8	425	T8	713SS	T43	8135	T18		
215	T23	425BR	T47	803	T19	8136	T39		
R225	T33	425E	T7, T42	804	T19	8136BR	T51		
RO225	T35	425HD	T14	812SS	T44	8137	T39		
R250	T33	426	T8	813	T9, T42	8138	T39		
RO250	T35	426BR	T47	813BR	T46	8139	T39		
Type 1	T41	426E	T7	813SS	T43	8140BR	T51		
Type 3	T41	426HD	T15	814	T40	8142	T38		
Type 4	T41	427	T8	814SS	T40, T45	8143	T38		
Type 5	T41	427BR	T47	818	T40	8144	T38		
315	T23	427E	T7, T42	818SS	T40, T45	8144BR	T51		
315BR	T49	428BR	T47	838	T40	8145	T38		
321	T25	428E	T7, T42	882	T39	8145BR	T51		
322	T25	429E	T7	883SS	T45	8146	T38		
323	T24	429BR	T47	884	T19	8146BR	T51		
324	T24	430E	T7	884B/S	T25	8147	T38		
325	T24	430BR	T47	884-6	T31	8148	T38		
325BR	T49	431	T12	884-7	T31	8149	T38		
325HD	T14, T24	WA431	T12	884-8	T31	8150	T38		
		432	T12	884SS	T45	8163	T38		
		WA432	T12						

# RATINGS



**ADA COMPLIANT** Barrier Free Thresholds Meet the Requirements of ADA Standards for Accessible Design and ICC/ANSI A117.1 Accessible and Usable Buildings and Facilities.



**POSITIVE PRESSURE CERTIFIED by UL to ANSI/UL10C** Complies with IBC, NFPA 80 and NFPA 252 for Application to Hollow Metal Fire Doors Rated up to 3 hours, and Wood Fire Doors Rated up to 90 minutes.



**CERTIFIED by UL to CAN/ULC-S104 and ANSI/UL10B** Complies with NFPA 80 and NFPA 252 for Application to Hollow Metal Fire Doors Rated up to 3 hours, and Wood Fire Doors Rated up to 90 minutes.



**AIR FILTRATION TESTED** to ASTM E283, Standard Test Method for Determining Rate of Air Leakage Through Exterior Windows, Curtain Walls, and Doors.



**SLIP-RESISTANT** SIA Textured Surface is Available on All Thresholds. Our Process Embeds and Fuses Bits of Hot Nickel and Titanium into the Surface of the Threshold. Originally Developed for Use on Aircraft Carrier Decks, This Technology is Highly Slip-Resistant and Will Not Wear Off.



**ANSI/BHMA CERTIFIED** Certified Thresholds Comply with American National Standard for Thresholds ANSI/BHMA A156.21 and are Listed in the BHMA Certified Products Directory.



Online Product Listings at [ul.com/database](http://ul.com/database).

## ANSI/BHMA

The following explains ANSI/BHMA numbers which identify material and type of products. For products that meet ANSI/BHMA Standards, look for the BHMA certified logo next to the product in our catalog. For a complete listing refer to the BHMA Certified Products Directory online at [buildershardware.com](http://buildershardware.com).



### ANSI/BHMA A156.21 American National Standard for Thresholds

1 Product Section	2 Material	3 Configuration	4 Surface	5 Description	6 Description
"J" Designates Architectural Door Trim, Thresholds	1. Architectural Brass or Bronze 3. Aluminum 5. Stainless Steel 7. Rubber & Similar Non-Metallics 0. Other	1. Compressing Top 2. Flat Saddle 3. Half Saddle 4. Interlocking 5. Rabbeted, Latching/ Panic 6. Rabbeted, Latching/ Panic w/Gasket 7. Plate 8. Ramped 9. Saddle for Floor Closer 0. None Designated	1. Fluted 2. Fluted w/Slip-Resistant Finish 3. Smooth 4. Smooth w/ Slip-Resistant Finish	1. Applied Stop 2. Applied Stop w/ Gasket 3. Barrier Free 4. Carpet Separator 5. Ends Mitered 6. Expansion Assembly 7. Hook Strip Applied to Door 8. Offset 9. Thermal Barrier 0. None Designated	1. Applied Stop 2. Applied Stop w/ Gasket 3. Barrier Free 4. Carpet Separator 5. Ends Mitered 6. Expansion Assembly 7. Hook Strip Applied to Door 8. Offset 9. Thermal Barrier 0. None Designated  Suffix- HD = Heavy Duty

# MATERIALS AND FINISHES

## MATERIALS

Thresholds are Aluminum Alloy 6063, T5 Temper, Unless Noted.

Cover Plates 818 and 814 are Aluminum Alloy 3003, H14 Hardness.

Cover Plate 838 is Aluminum Alloy 5052, H32 Hardness.

Architectural Bronze Thresholds are Alloy CDA 385 (Copper Alloy No. C38500), Architectural Bronze.

Stainless Steel Thresholds and Cover Plates are Type 304, Known for Its Excellent Corrosion Resistance, High Tensile Strength and Resistance to Oxidation.

## FINISHES

				NGP Suffix
Aluminum:	Mill Finish	ANSI/BHMA 719	US27	None
	Dark Bronze / Black Anodized	ANSI/BHMA 711	US19	DKB
	Polished	ANSI/BHMA 717		POL
	Slip-Resistant			SIA
Architectural Bronze:	Satin Finish	ANSI/BHMA 728	US4	BR
	Dark Bronze Oil Rubbed	ANSI/BHMA 722	US10B	BR-DKB
	Polished	ANSI/BHMA 721	US3	BR-POL
	Slip-Resistant			BR-SIA
Stainless Steel:	Mill Finish			SS
	Brushed (#4)	ANSI/BHMA 630	US32D	SS-Brushed
	Polished	ANSI/BHMA 629	US32	SS-POL
	Slip-Resistant			SS-SIA

## SIA (SLICK IT AIN'T) SLIP-RESISTANT FINISH

SIA (Slick It Ain't) finish is our slip-resistant textured surface, available on all thresholds up to 24" wide and on 818 aluminum and brass cover plates up to 10" wide.

Our SIA technology embeds bits of hot nickel and titanium into the surface of the threshold using a high pressure thermo-electrostatic process. It was originally developed for use on aircraft carrier decks. SIA finish is very durable and will not wear off.

This results in a slip-resistant surface that is similar to high grit sandpaper.

Aluminum and Stainless Steel SIA finish thresholds are a pewter color. Architectural Bronze SIA finish thresholds are a brass color.



Look for this SIA Icon to Find Products With this Optional Slip-Resistant Finish.



# GENERAL INFORMATION

Aluminum and Architectural Bronze Thresholds and Assembly Components are furnished longer than ordered to allow for field sizing and fitting.

½" is added to thresholds under 61"; 1" is added to thresholds over 61", unless ordered as "net" cut.

Unless noted, thresholds are punched for and provided with fasteners. Assembly parts are supplied undrilled with fasteners provided.

Special Drilling and Notching is available; details must be provided with the order.

Stainless Steel Thresholds are supplied "net" cut.

Radiation shielding with .030" thick Lead is available on most thresholds. Specify "Lead Lined".

Catalog Illustrations are full scale, except as noted.

## RETURNED CLOSED ENDS

Return Closed Ends (RCE's) are available on most beveled thresholds.

The corner is miter cut on a 45 degree angle and returned to the face of the door frame for a neat, clean, finished appearance. Specify "RCE".

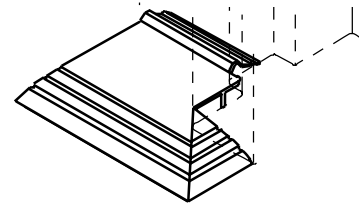

## CUSTOM FABRICATED THRESHOLDS

Our Custom Fabrication Department specializes in producing custom thresholds to your specifications. Submit your details to our Technical Department for a quotation and drawing for your approval. Components Shown on pages T38 and T51 are used to build special assemblies like the one illustrated below. Aluminum, Brass and Stainless Steel Cover Plates are also custom formed and welded to meet special requirements.

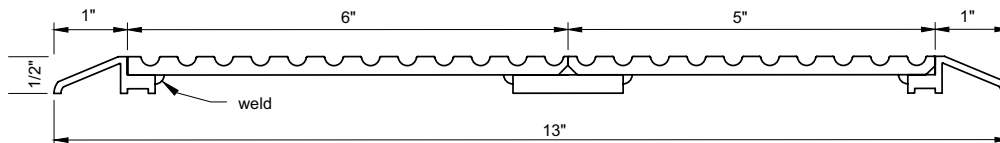

8137 x 8146 (Rip to 6") x 8145 x 8137 x Bar4 x Welded profile Assembly View

## SPORTS FLOOR THRESHOLD ASSEMBLIES

Wood gymnasium sports floors are designed to be free floating. We offer threshold assemblies to cover the transition from the primary floor to the sports floor. As the sports floor shifts, the top plate of the threshold assembly moves, allowing for expansion and contraction.

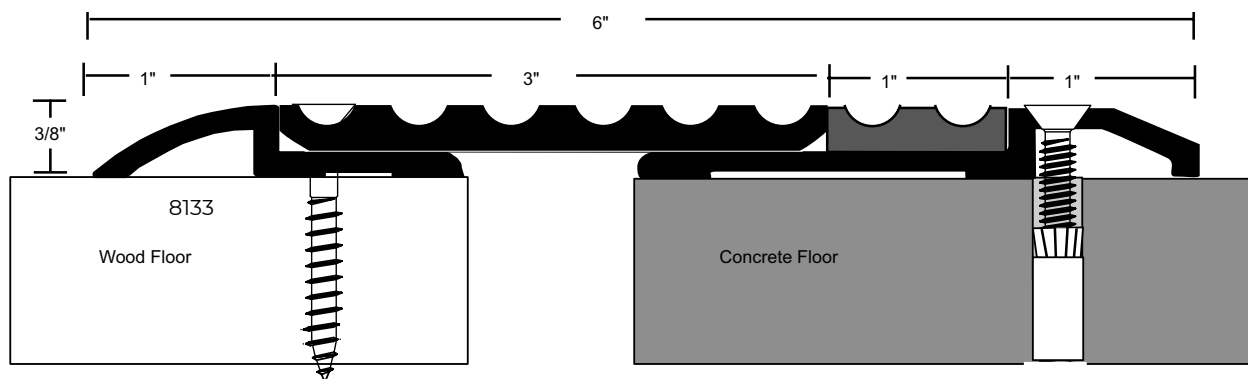

8133 x 8143 x 8168N (Neoprene) x 8139 x 10-24 MS/LA

Also available in ½" height and in other widths - contact NGP Technical Department

# LEED GREEN BUILDING

---

LEED (Leadership in Energy and Environmental Design) Green Building Rating System® is a national standard for developing high-performance, sustainable buildings developed by the U. S. Green Building Council. Our current LEED letter containing LEED qualification information for all our products is available at [ngp.com](http://ngp.com).

## **MRC2 Building Product Disclosure and Optimization - Environmental Product Declaration (EPD)**

National Guard Products is able to provide Type III Product Specific Environmental Product Declarations for its Threshold, Gasketing, Lite Kits, Louvers and Continuous Geared Hinge products. The EPDs can be found at: [ngp.com/epds](http://ngp.com/epds).

## **MRC3 Building Product Disclosure and Optimization - Sourcing of Raw Materials**

National Guard Products is able to provide a third-party reviewed corporate sustainability report that includes the environmental impacts

of extraction operations and activities associated with National Guard Products' supply chain. This report was created using the Global Reporting Initiative (GRI) Sustainability Reporting framework and satisfies MRC3 Option 1. The report can be found at: [ngp.com/report](http://ngp.com/report).

For Option 2 of the MRC3 credit, products purchased from National Guard Products are eligible to participate in the NGP Extended Producer Responsibility program, RE-NGP, managed by National Guard Products.

Additionally for Option 2 of the MRC3 credit, average percentages of recycled materials utilized in and contained in NGP products may be found at: [ngp.com/leed](http://ngp.com/leed).

## **MRC4 Building Product Disclosure and Optimization - Material Ingredients**

National Guard Products is able to provide product specific Health Product Declarations for its Threshold, Gasketing, Lite Kits and Louver products. The HPDs can be found at: [ngp.com/hpds](http://ngp.com/hpds).

# BUY AMERICAN REQUIREMENTS

---

## **Buy American Act**

Over 99% of our products are produced in the United States as a domestic construction material, as defined in the Buy American Act (BAA) of March 1933 and amended by the Buy American Act of 1988 and FAR 52.225-9. A Buy American certificate may be obtained on our website [ngp.com](http://ngp.com).

## **Buy America**

Most of our products comply with Buy America Requirements of 49 U.S.C. 5323(j)(1), and the applicable regulations in 49 CFR part 661. Contact us for a Certificate of Compliance for your project.

Components of unknown origin are considered to have been produced or manufactured outside the United States.

## **Build America, Buy America**

Many of our products comply with the Infrastructure Investment and Jobs Act, Build America, Buy America requirements. Contact us for a Certificate of Compliance for your project.

# SADDLE THRESHOLDS

All Products On This Page



**424E**  
Mill Aluminum Saddle  
Threshold, 1/2" x 4"

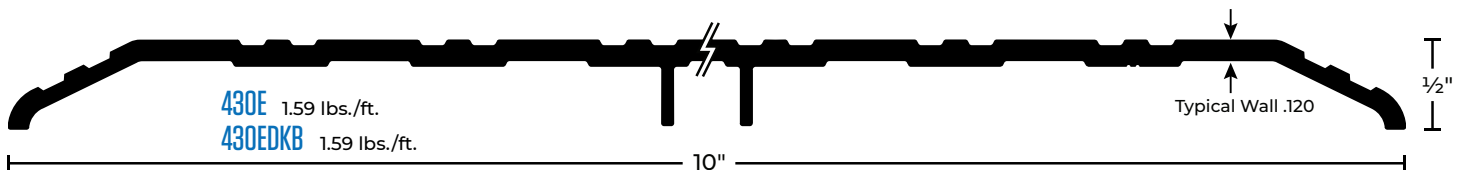
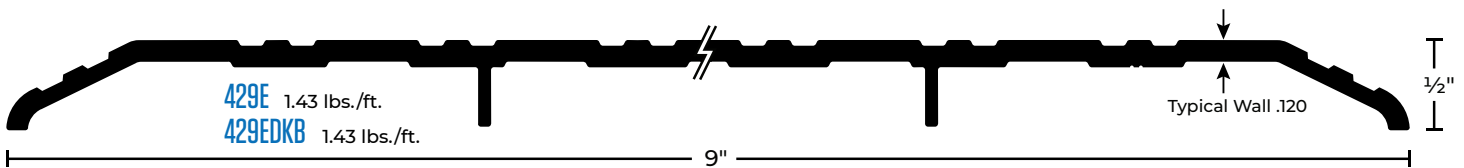
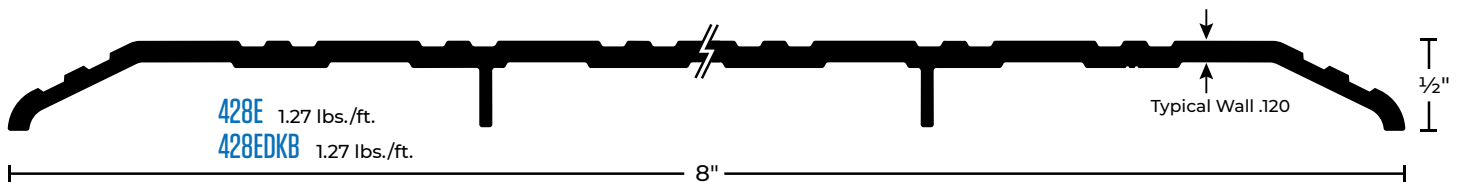
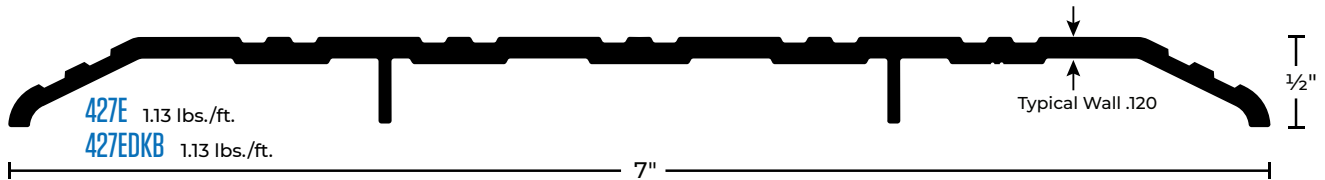
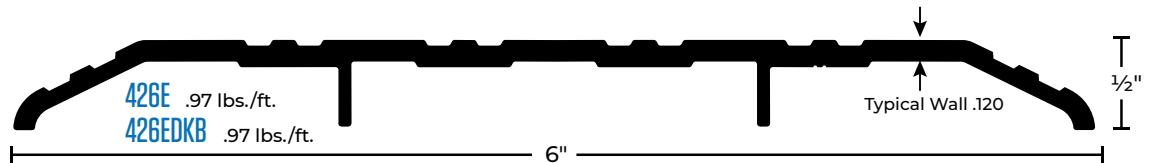
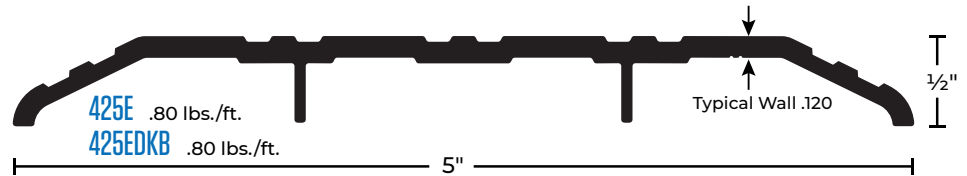
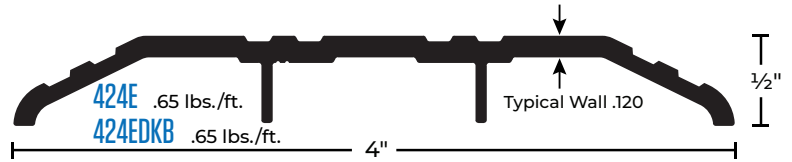

## MATERIALS & FINISHES

- Mill Aluminum
- DKB - Aluminum Dark Bronze/Black Anodized



## OPTIONAL SIA SLIP-RESISTANT FINISH

For Use in Areas Where Conditions Can Be Hazardous and Safety Is a Priority.

## FASTENERS

- #10 x 1-1/2" FH Zinc-Plated Wood Screws Furnished. Dark Bronze Supplied With DKB.



# SADDLE THRESHOLDS

All Products On This Page

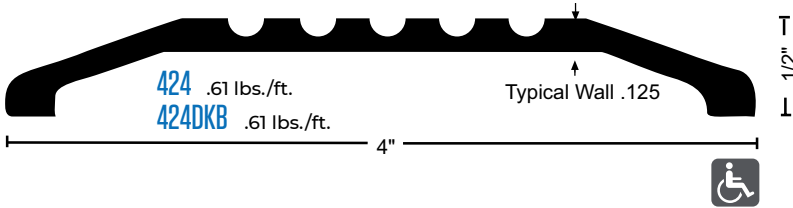
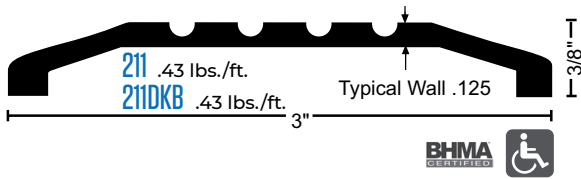

**424**  
Mill Aluminum Saddle  
Threshold, 1/2" x 4"

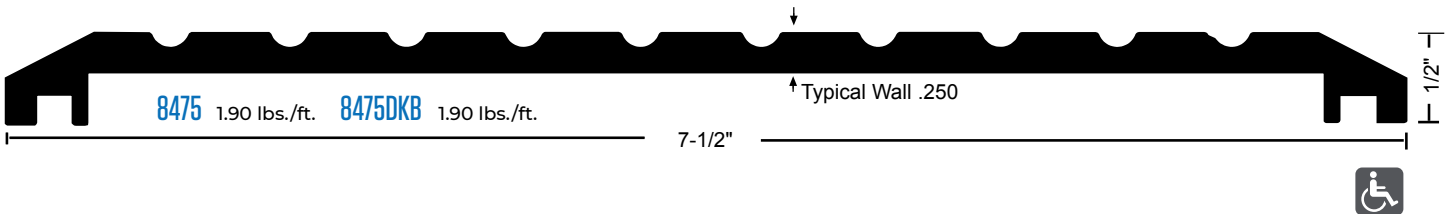
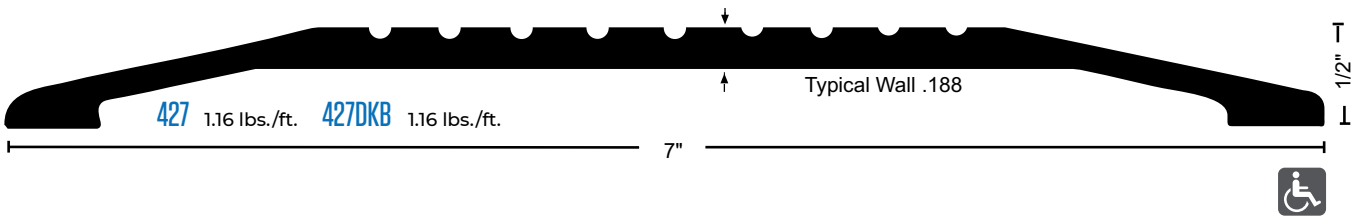
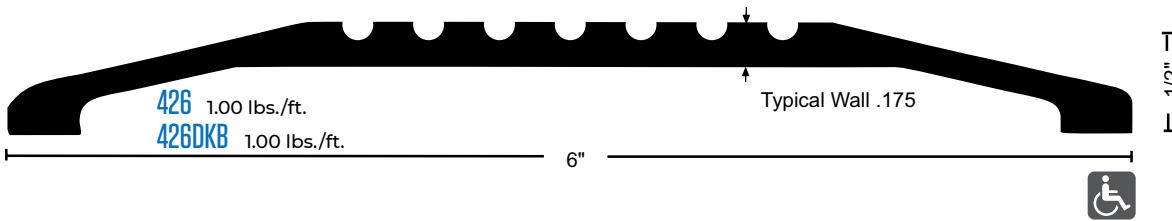
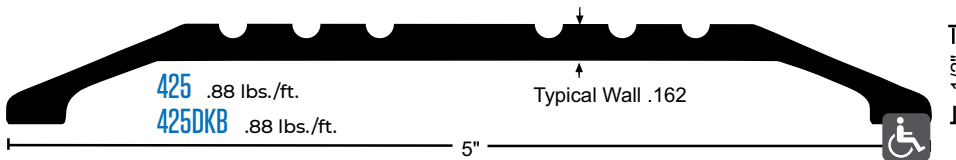

## MATERIALS & FINISHES

- Mill Aluminum
- DKB - Aluminum Dark Bronze/Black Anodized



## OPTIONAL SIA SLIP-RESISTANT FINISH

For Use in Areas Where Conditions Can Be Hazardous and Safety Is a Priority.

## FASTENERS

- #10 x 1-1/2" FH Zinc-Plated Wood Screws Furnished. Dark Bronze Supplied With DKB.

# SADDLE THRESHOLDS

All Products On This Page



**513**  
Mill Aluminum  
Saddle Threshold,  
¼" x 5"

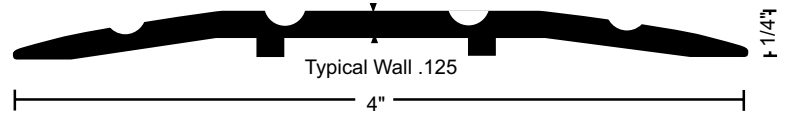

**413** 53 lbs./ft.  
**413DKB** .53 lbs./ft.

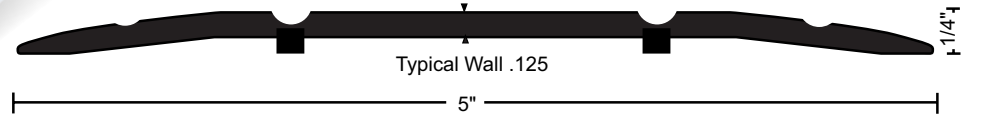

**513** .68 lbs./ft.  
**513DKB** .68 lbs./ft.

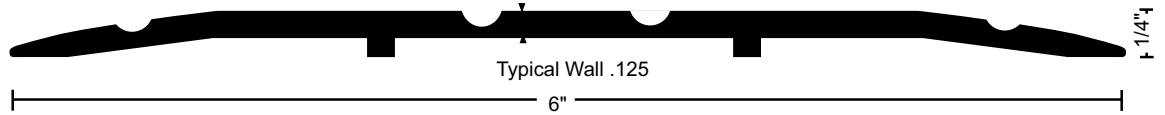

**613** 88 lbs./ft.  
**613DKB** .88 lbs./ft.

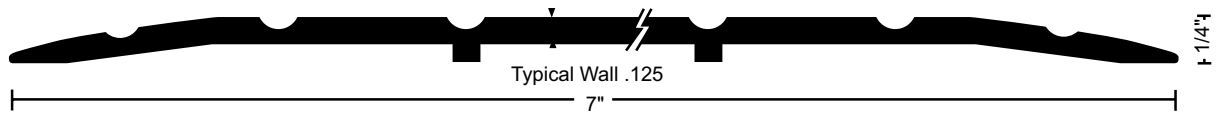

**713** 1.01 lbs./ft  
**713DKB** 1.01 lbs./ft.

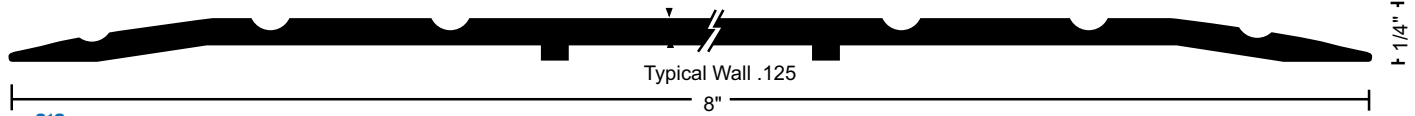

**813** 1.20 lbs./ft  
**813DKB** 1.20 lbs./ft.

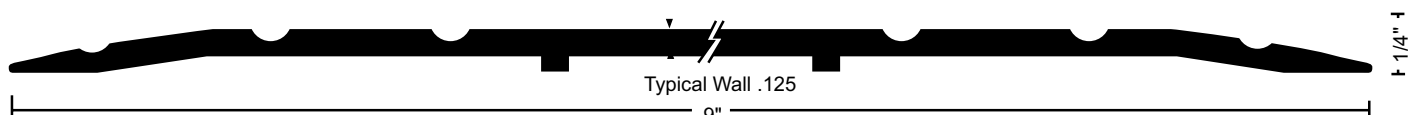

**913** 1.41 lbs./ft  
**913DKB** 1.41 lbs./ft.

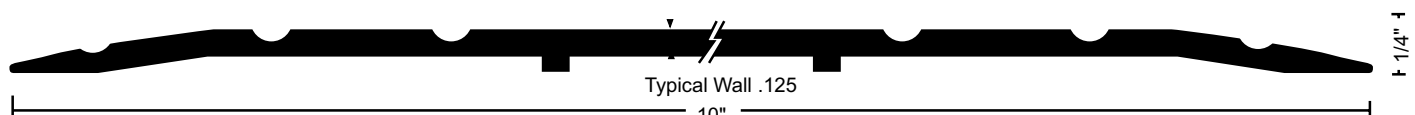

**1013** 1.63 lbs./ft  
**1013DKB** 1.63 lbs./ft.

## MATERIALS & FINISHES

- Mill Aluminum
- DKB - Aluminum Dark Bronze/Black Anodized



## OPTIONAL SIA SLIP-RESISTANT FINISH

For Use in Areas Where Conditions Can Be Hazardous and Safety Is a Priority.

## FASTENERS

- #10 x 1-½" FH Zinc-Plated Wood Screws Furnished. Dark Bronze Supplied With DKB.

# SADDLE THRESHOLDS

All Products On This Page

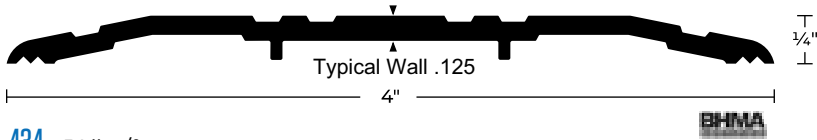

**434** .54 lbs./ft.  
**434DKB** .54 lbs./ft.

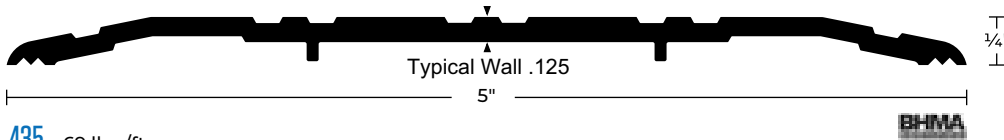

**435** .69 lbs./ft.  
**435DKB** .69 lbs./ft.

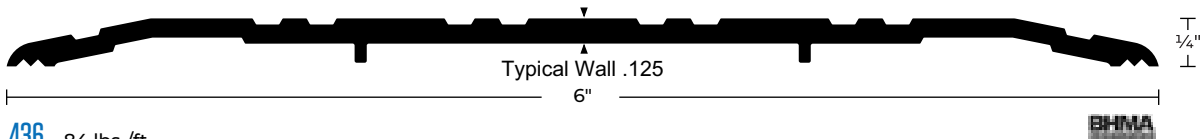

**436** .84 lbs./ft.  
**436DKB** .84 lbs./ft.

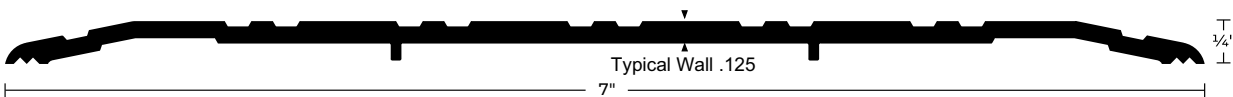

**437** .99 lbs./ft.  
**437DKB** .99 lbs./ft.

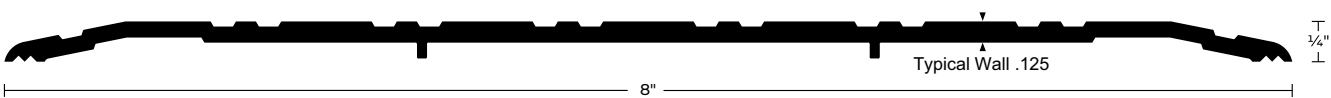

**438** 1.14 lbs./ft.  
**438DKB** 1.14 lbs./ft.



**439** 1.28 lbs./ft.  
**439DKB** 1.28 lbs./ft.

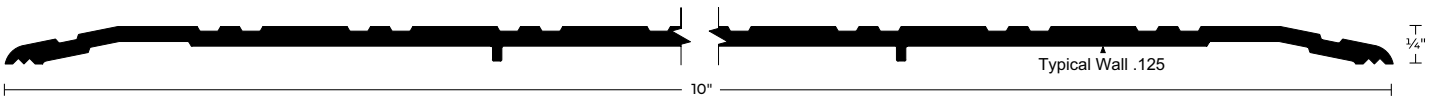

**440** 1.43 lbs./ft.  
**440DKB** 1.43 lbs./ft.

## MATERIALS & FINISHES

- Mill Aluminum
- DKB - Aluminum Dark Bronze/Black Anodized

## FASTENERS

- #10 x 1-1/2" FH Zinc-Plated Wood Screws Furnished. Dark Bronze Supplied With DKB.

# EXTENDED WIDTH THRESHOLDS

All Products On This Page

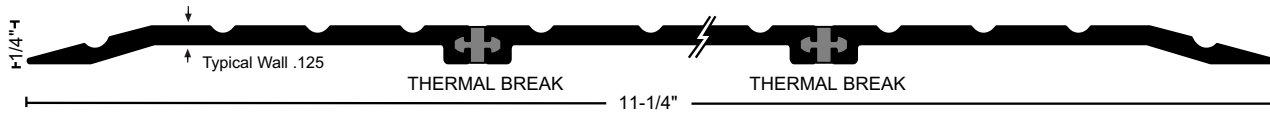

**8113** 1.57 lbs./ft.  
**8113DKB** 1.57 lbs./ft.

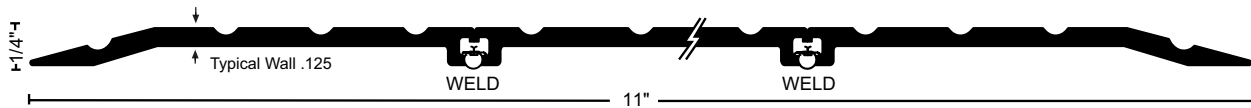

**WA8113** 1.55 lbs./ft.  
**WA8113DKB** 1.55 lbs./ft.

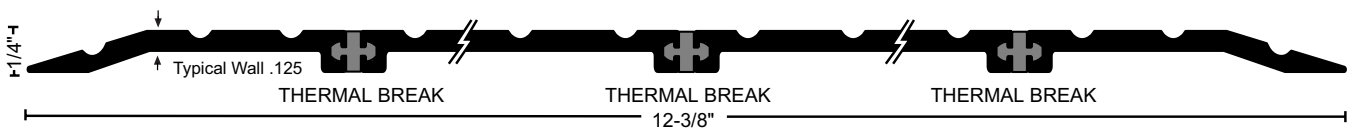

**8213** 1.74 lbs./ft.  
**8213DKB** 1.74 lbs./ft.

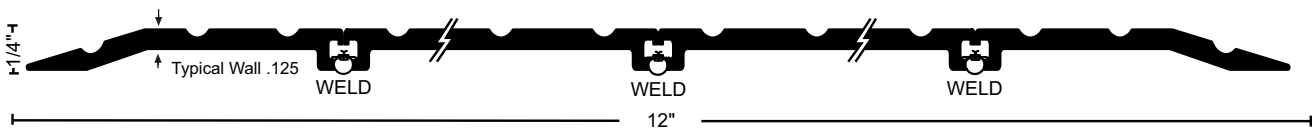

**WA8213** 2.27 lbs./ft.  
**WA8213DKB** 2.27 lbs./ft.

## MATERIALS & FINISHES

- Mill Aluminum
- DKB - Aluminum Dark Bronze/Black Anodized



## OPTIONAL SIA SLIP-RESISTANT FINISH

For Use in Areas Where Conditions Can Be Hazardous and Safety Is a Priority.

## FASTENERS

- #10 x 1-1/2" FH Zinc-Plated Wood Screws Furnished. Dark Bronze Supplied With DKB.



# EXTENDED WIDTH THRESHOLDS

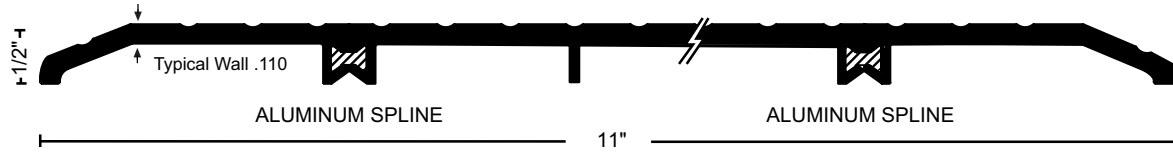

**431** 1.75 lbs./ft.  
**431DKB** 1.75 lbs./ft.

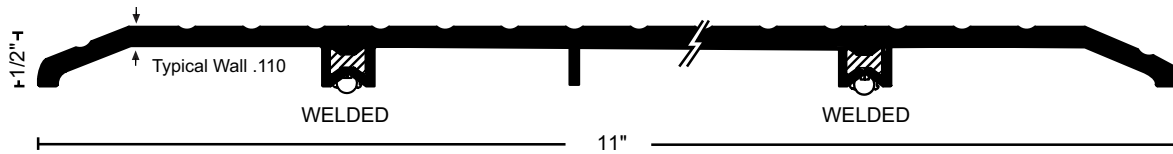

**WA431** 1.75 lbs./ft.  
**WA431DKB** 1.75 lbs./ft.

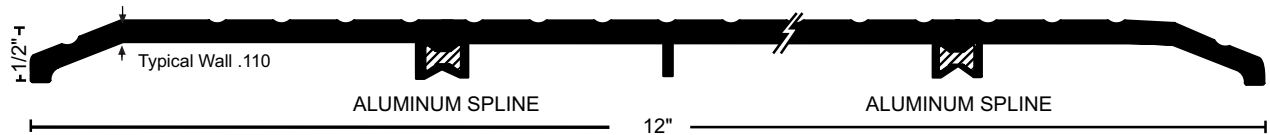

**432** 1.87 lbs./ft.  
**432DKB** 1.87 lbs./ft.

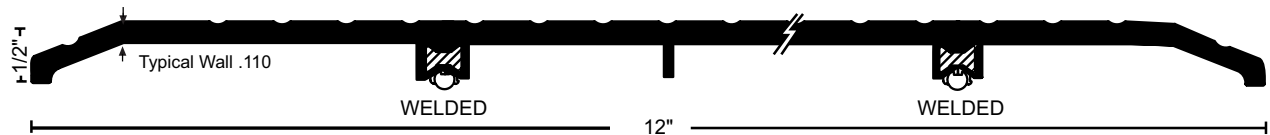

**WA432** 1.87 lbs./ft.  
**WA432DKB** 1.87 lbs./ft.

## MATERIALS & FINISHES

- Mill Aluminum
- DKB - Aluminum Dark Bronze/Black Anodized



## OPTIONAL SIA SLIP-RESISTANT FINISH

For Use in Areas Where Conditions Can Be Hazardous and Safety Is a Priority.

## FASTENERS

- #10 x 1-1/2" FH Zinc-Plated Wood Screws Furnished. Dark Bronze Supplied With DKB.

# SMOOTH SURFACE THRESHOLDS

All Products On This Page



**410**  
Mill Aluminum  
Smooth Surface  
Saddle Threshold,  
1/4" x 2 1/2"

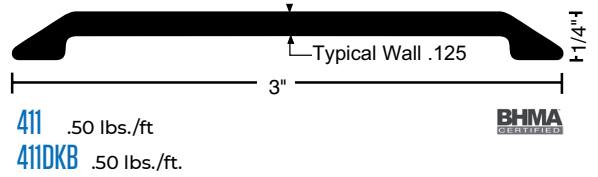
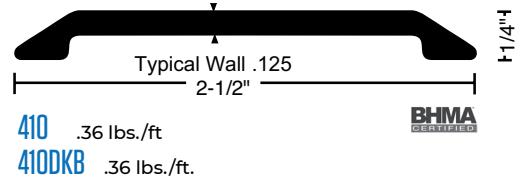

▶ Recommended to Provide the Best Results Where Automatic Door Bottoms are Used.

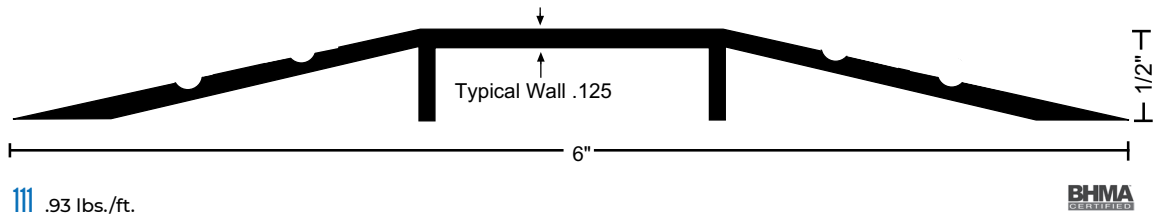
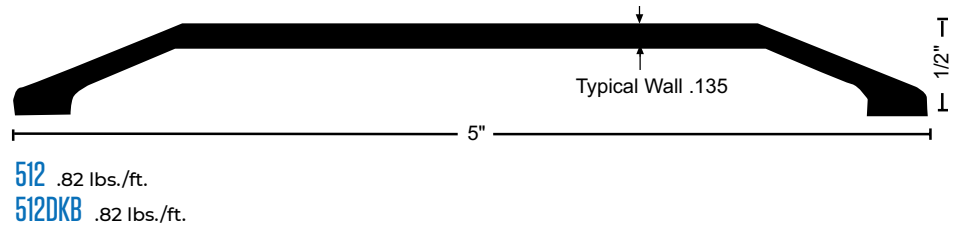
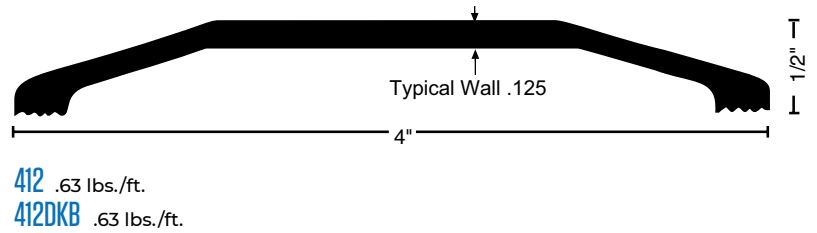

## MATERIALS & FINISHES

- Mill Aluminum
- DKB - Aluminum Dark Bronze/Black Anodized



## OPTIONAL SIA SLIP-RESISTANT FINISH

For Use in Areas Where Conditions Can Be Hazardous and Safety Is a Priority.

## FASTENERS

- #10 x 1-1/2" FH Zinc-Plated Wood Screws Furnished. Dark Bronze Supplied With DKB.

# HEAVY-DUTY THRESHOLDS

All Products On This Page



- For Use Where Forklift or Vehicular Traffic Occurs
- Recommended for Delivery/Storage Doorways Where Heavier Loads Travel
- BHMA Certified To ANSI A156.21 Heavy-Duty 10,000 Lb. Load Test
- Optional SIA Slip-Resistant Finish Recommended in Moisture Prone Areas



**425HD**  
ADA Compliant  
EXTRA Heavy-Duty Aluminum  
Threshold, 1/2" x 5"

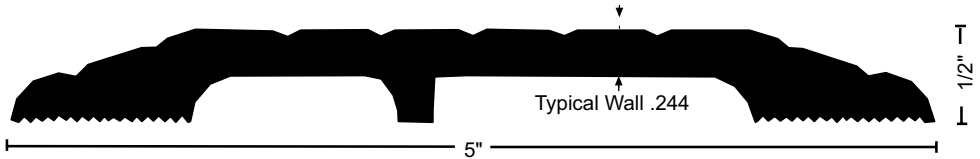

**425HD** 1.6 lbs./ft.  
**425HDDKB** 1.6 lbs./ft.



**513HD** 1.4 lbs./ft.  
**513HDDKB** 1.4 lbs./ft.

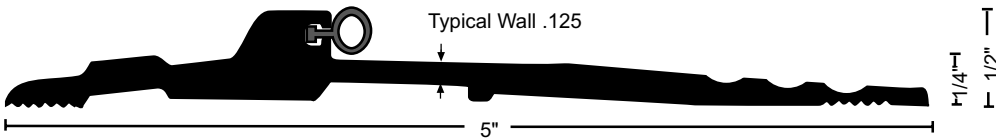

**896HD** 1.01 lbs./ft  
**896HDDKB** 1.01 lbs./ft

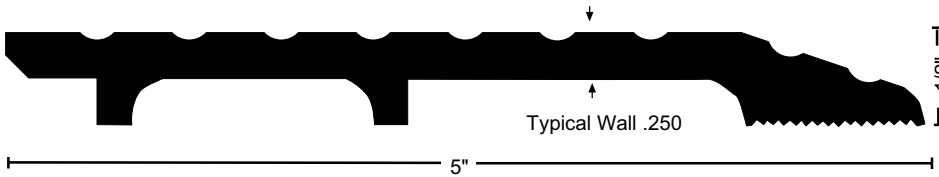

**325HD** 1.65 lbs./ft  
**325HDDKB** 1.65 lbs./ft

**BUMPER SEAL**  
Seals Against the Door to Provide Weather Resistance

**BUMPER SEAL OPTIONS**

- V** Vinyl\*\*
- N** NGP-TPV
- S** Silicone

\*\*Vinyl ("V") Supplied Unless Other Material Specified

\* When Installed With the Non-Beveled Edge Flush With Flooring, or Where No Greater Than 1/4" Vertical Rise Occurs

**MATERIALS & FINISHES**

- Mill Aluminum
- DKB - Aluminum Dark Bronze/Black Anodized



**OPTIONAL SIA SLIP-RESISTANT FINISH**

For Use in Areas Where Conditions Can Be Hazardous and Safety Is a Priority.

**FASTENERS**

- #10 x 1-1/2" FH Zinc-Plated Wood Screws Furnished. Dark Bronze Supplied With DKB.

# HEAVY-DUTY THRESHOLDS

All Products On This Page



- ▶ For Use Where Forklift or Vehicular Traffic Occurs
- ▶ Recommended for Delivery/Storage Doorways Where Heavier Loads Travel
- ▶ Optional SIA Slip-Resistant Finish Recommended in Moisture Prone Areas

**613HD**  
 ADA Compliant  
 Heavy-Duty  
 Aluminum Threshold,  
 ¼" x 6"

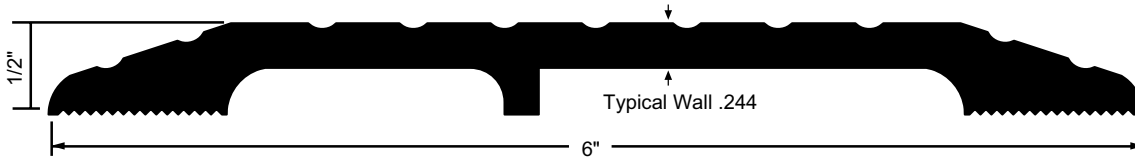

**426HD** 1.98 lbs./ft.  
**426HDDKB** 1.98 lbs./ft.

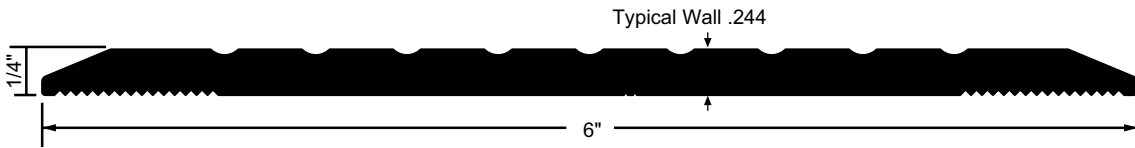

**613HD** 1.66 lbs./ft.  
**613HDDKB** 1.66 lbs./ft.



BHMA Certified to ANSI/BHMA A156.21  
 Heavy-Duty 10,000 lb. Load Test

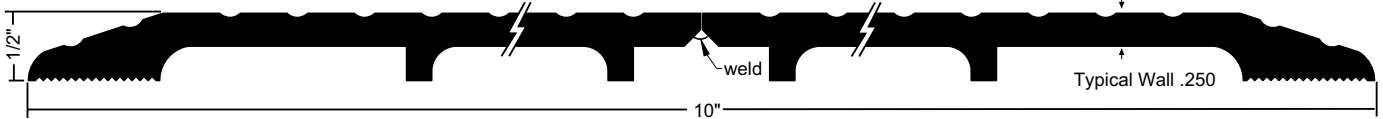

**325HD x 325HD Welded** 3.33 lbs./ft.  
**325HDDKB x 325HDDKB Welded** 3.33 lbs./ft.



BHMA Certified to ANSI/BHMA A156.21  
 Heavy-Duty 10,000 lb. Load Test

## MATERIALS & FINISHES

- Mill Aluminum
- DKB - Aluminum Dark Bronze/Black Anodized



## OPTIONAL SIA SLIP-RESISTANT FINISH

For Use in Areas Where Conditions Can Be Hazardous and Safety Is a Priority.

## FASTENERS

- #10 x 1-½" FH Zinc-Plated Wood Screws Furnished. Dark Bronze Supplied With DKB.



# BUMPER SEAL THRESHOLD

ADJUSTABLE ADA COMPLIANT

All Products On This Page

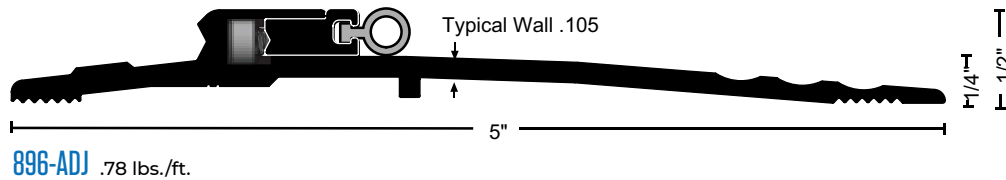

896-ADJ .78 lbs./ft.

- ▶ Stainless Steel Adjustment Screws on 10" Centers  
Allow Adjustment Without Re-Positioning  
Mounting Location
- ▶ Adjusting Range 1/4"
- ▶ Adjust Seal Using 7/64" Allen Wrench



## 896S-ADJ

Adjustable ADA  
Compliant Aluminum  
Bumper Threshold,  
1/2" x 5" with Silicone  
Bumper Seal

### MATERIALS & FINISHES

- Mill Aluminum
- DKB - Aluminum Dark Bronze/  
Black Anodized



### OPTIONAL SIA SLIP-RESISTANT FINISH

For Use in Areas Where  
Conditions Can Be  
Hazardous and Safety Is  
a Priority.

### FASTENERS

- #10 x 1-1/2" FH Zinc-Plated  
Wood Screws Furnished. Dark  
Bronze Supplied With DKB.



### BUMPER SEAL

Seals Against the Door to  
Provide Weather Resistance

#### BUMPER SEAL OPTIONS

- |   |          |
|---|----------|
| V | Vinyl**  |
| N | NGP-TPV  |
| S | Silicone |

\*\*Vinyl ("V") Supplied Unless Other  
Material Specified



### OPTIONAL SILICONE BUMPER SEAL "S"

Provides an STC  
Rating of STC 52

# BUMPER SEAL THRESHOLDS

ADA COMPLIANT

All Products In This Section

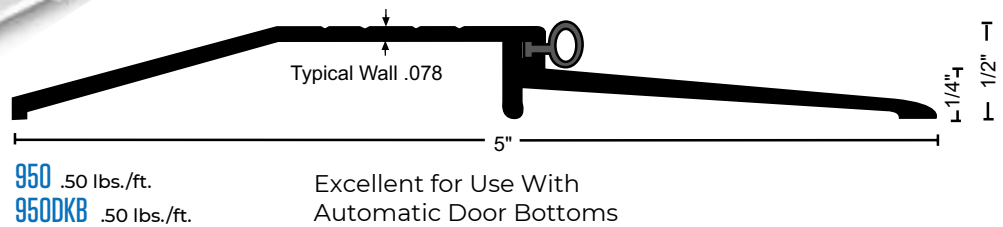
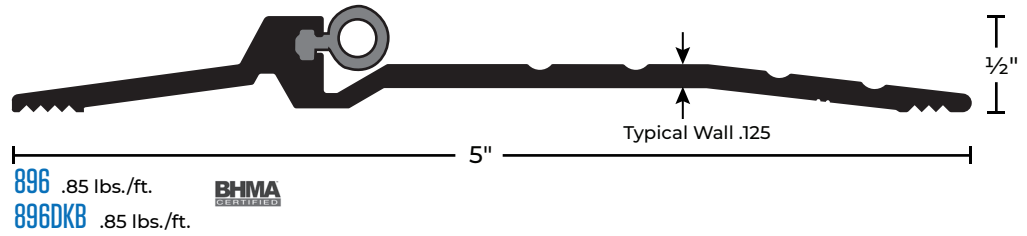

## 896V

ADA Compliant Aluminum Bumper Threshold, 1/2" x 5" With Vinyl Bumper Seal

# STOP STRIPS

All Products In This Section

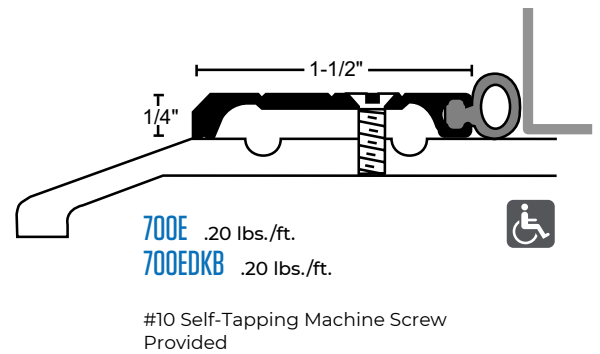
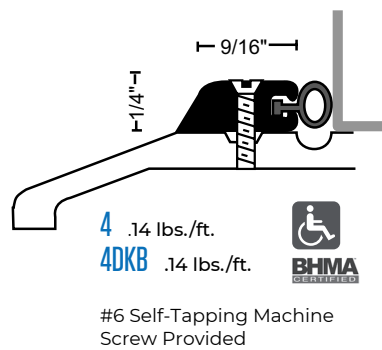
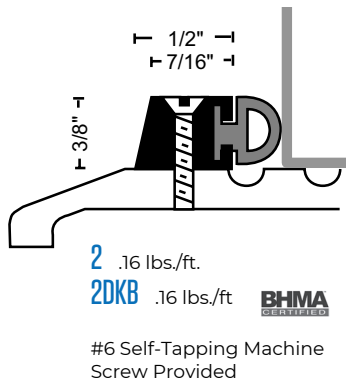

## MATERIALS & FINISHES

- Mill Aluminum
- DKB - Aluminum Dark Bronze/Black Anodized



## OPTIONAL SIA SLIP-RESISTANT FINISH

For Use in Areas Where Conditions Can Be Hazardous and Safety is a Priority.

## FASTENERS

- #10 x 1-1/2" FH Zinc-Plated Wood Screws Furnished. Dark Bronze Supplied With DKB.



## BUMPER SEAL

Seals Against the Door to Provide Weather Resistance

### BUMPER SEAL OPTIONS

- V** Vinyl\*\*
- N** NGP-TPV
- S** Silicone

\*\*Vinyl ("V") Supplied Unless Other Material Specified

# BUMPER SEAL THRESHOLDS

All Products On This Page



## 897S

Aluminum & Silicone  
Bumper Seal  
Threshold, 1" x 4"

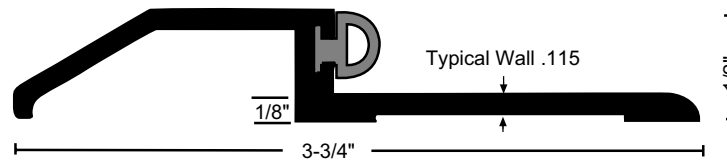

**8135** .60 lbs./ft.

**8135DKB** .60 lbs./ft.

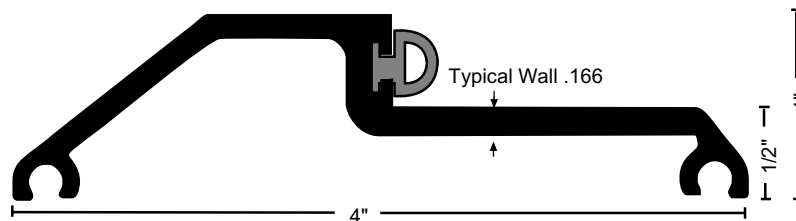

**897** .91 lbs./ft.

**897DKB** .91 lbs./ft.

### MATERIALS & FINISHES

- Mill Aluminum
- DKB - Aluminum Dark Bronze/Black Anodized



### OPTIONAL SIA SLIP-RESISTANT FINISH

For Use in Areas Where Conditions Can Be Hazardous and Safety Is a Priority.

### FASTENERS

- #10 x 1-1/2" FH Zinc-Plated Wood Screws Furnished. Dark Bronze Supplied With DKB.



### BUMPER SEAL

Seals Against the Door to Provide Weather Resistance

#### BUMPER SEAL OPTIONS

- V** Vinyl\*\*
- N** NGP-TPV
- S** Silicone

\*\*Vinyl ("V") Supplied Unless Other Material Specified

# BUMPER SEAL THRESHOLDS

All Products On This Page



**804V**  
Mill Aluminum, Vinyl  
Bumper Seal Threshold,  
7/8" x 5"

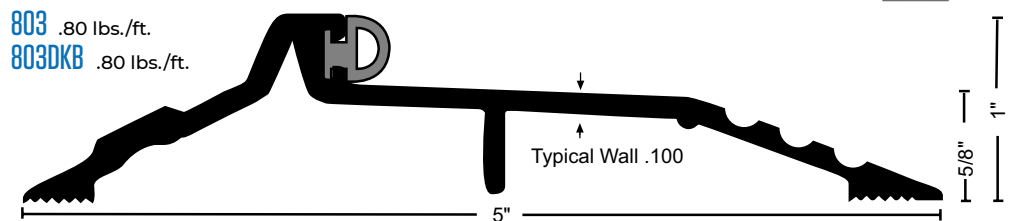
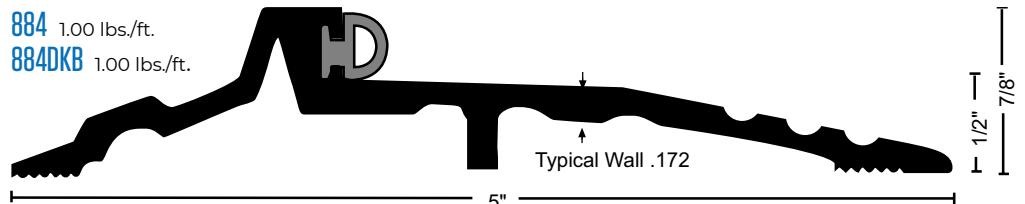
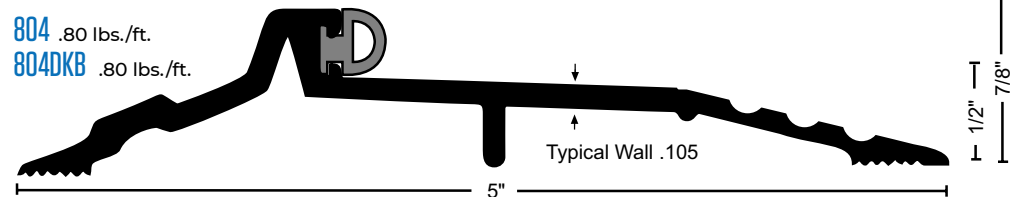
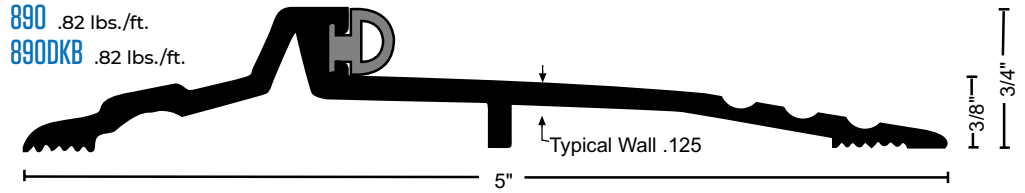

## MATERIALS & FINISHES

- Mill Aluminum
- DKB - Aluminum Dark Bronze/Black Anodized



## OPTIONAL SIA SLIP-RESISTANT FINISH

For Use in Areas Where Conditions Can Be Hazardous and Safety Is a Priority.

## FASTENERS

- #10 x 1-1/2" FH Zinc-Plated Wood Screws Furnished. Dark Bronze Supplied With DKB.



## BUMPER SEAL

Seals Against the Door to Provide Weather Resistance

### BUMPER SEAL OPTIONS

- V** Vinyl\*\*
- N** NGP-TPV
- S** Silicone

\*\*Vinyl ("V") Supplied Unless Other Material Specified

# OFFSET THRESHOLDS

All Products in this Section

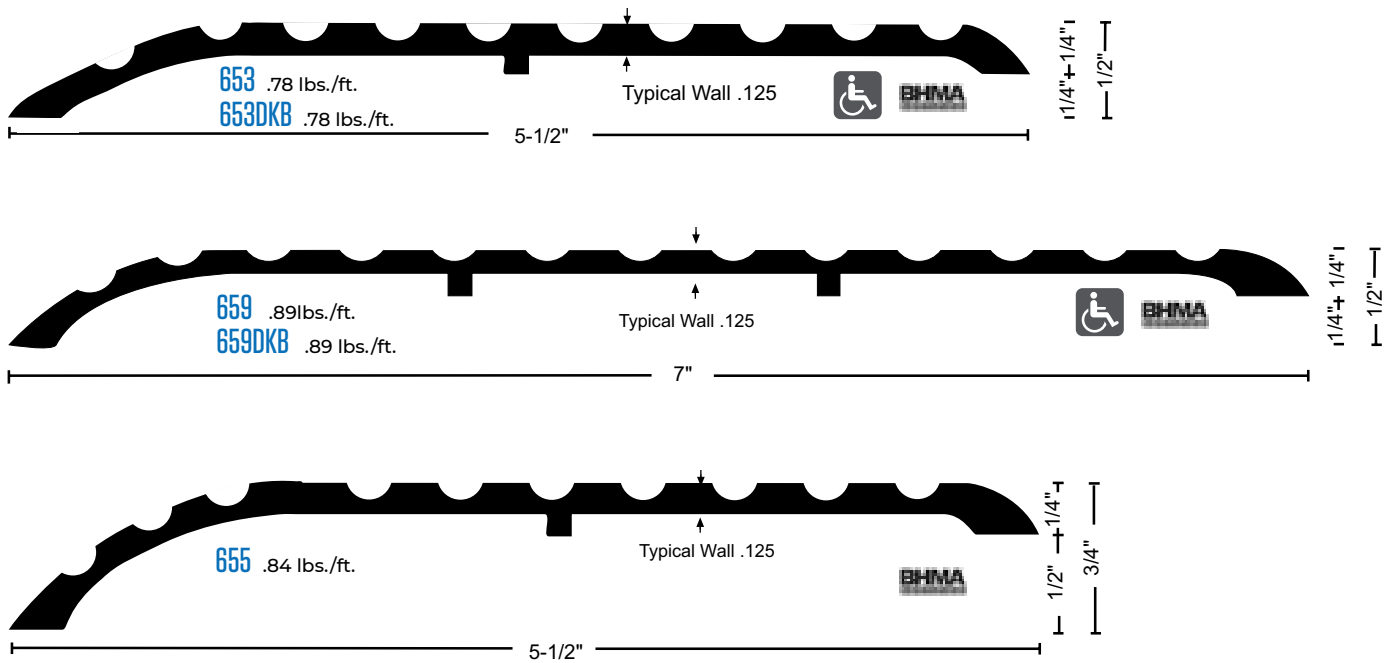

# CARPET AND TILE DIVIDERS AND EDGES

## CARPET AND TILE DIVIDERS

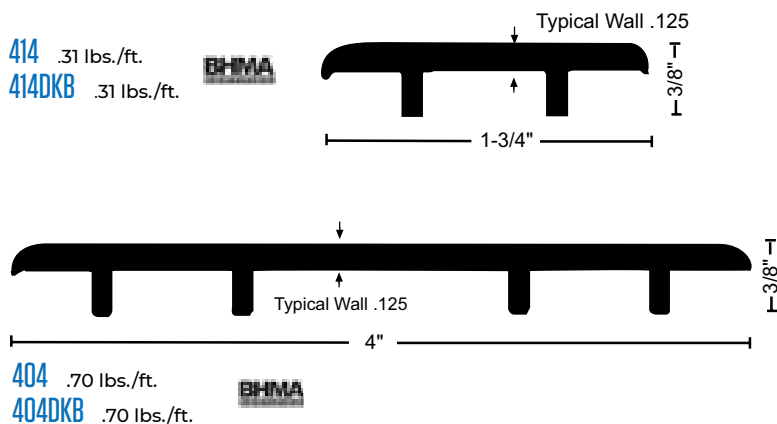

## CARPET EDGES

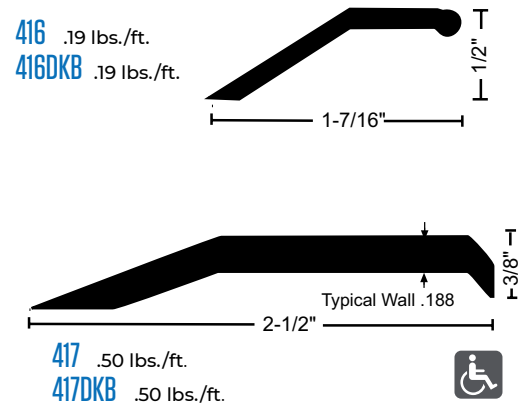

### MATERIALS & FINISHES

- Mill Aluminum
- DKB - Aluminum Dark Bronze/Black Anodized



### OPTIONAL SIA SLIP-RESISTANT FINISH

For Use in Areas Where Conditions Can Be Hazardous and Safety Is a Priority.

### FASTENERS

- #10 x 1-1/2" FH Zinc-Plated Wood Screws Furnished. Dark Bronze Supplied With DKB.

# DIVIDER THRESHOLDS

VINYL CARPET/TILE

All Products On This Page



- For Transition Between Two Different Carpets or Carpet to Tile.
- Easy to Install Using Adhesive Like NGP RR5007BL, Black RTV Silicone Rubber Construction Sealant
- Each Tube Bonds 4' of 398 or 399, 8' of 400 or 401, 12' of 402, or 15' of 407.



**407**  
Hospitality Vinyl  
Carpet/Tile Divider  
Threshold, 3/4" x 2 3/4"

\* When Installed as Illustrated  
Between Carpet and/or Tile

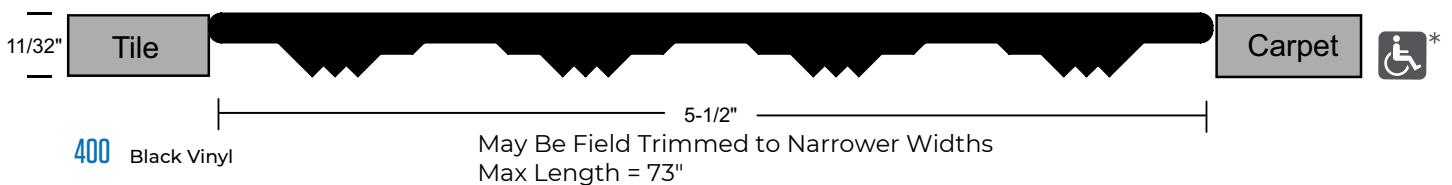
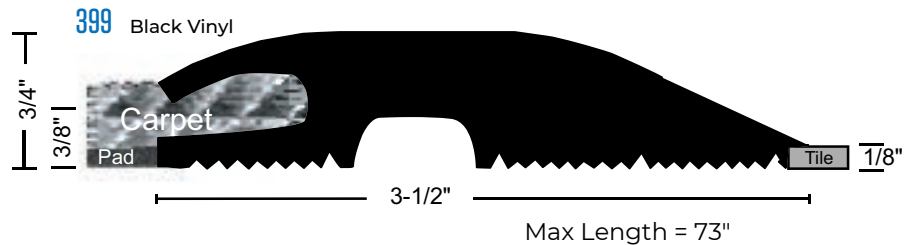
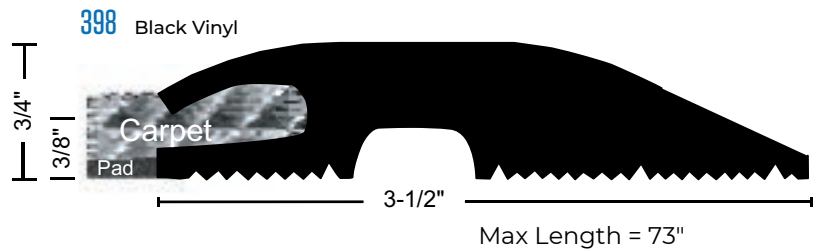
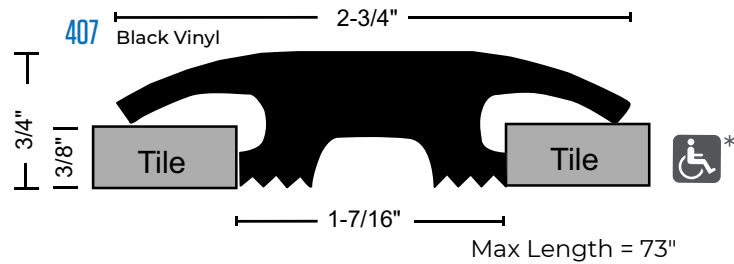
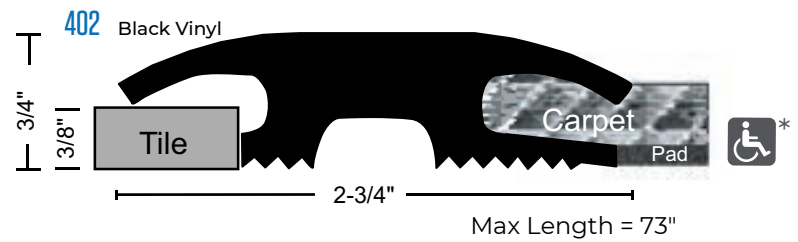
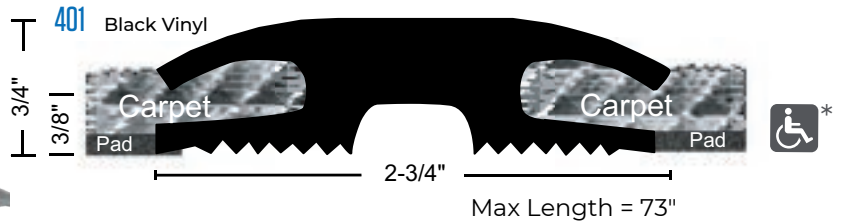

# DIVIDER THRESHOLDS

## COMMUNICATING DOOR

All Products On This Page



- For Transition Between Two Different Carpets
- Easy to Install Using Adhesive Like NGP RR5007BL, Black RTV Silicone Rubber Construction Sealant
- Each Tube Bonds 12' of 402, or 8' of 400

\*ADA Compliant When Installed as Illustrated Between Carpet

### 402x400x400x402 Black Vinyl

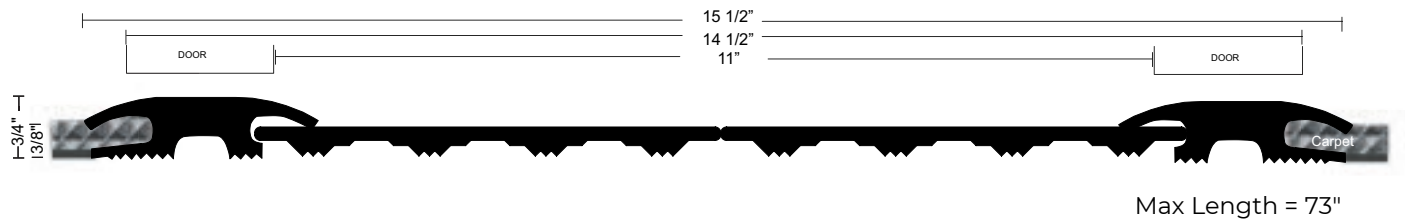

### 402x400x402 Black Vinyl

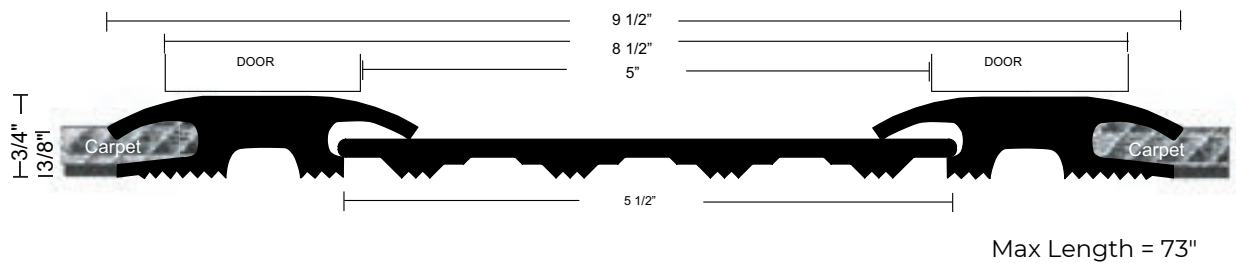

# COMPONENTS

## TRANSITION STRIPS, HALF SADDLE AND EXTENDED WIDTHS

All Products On This Page



### TRANSITION STRIPS

- Heavy-Duty - For Transition at Edge of 3/8" or 3/8" Tile
- Protects Edge of Tile
- Reduces Tripping Hazard
- Available in 96" Length Only
- 1/4 x 1 3/4 FH Concrete Anchor x T-27 (10 each furnished)

### MATERIALS & FINISHES

- Mill Aluminum
- DKB - Aluminum Dark Bronze/Black Anodized



### OPTIONAL SIA SLIP-RESISTANT FINISH

For Use in Areas Where Conditions Can Be Hazardous and Safety Is a Priority.

### FASTENERS

- #10 x 1-1/2" FH Zinc-Plated Wood Screws Furnished. Dark Bronze Supplied With DKB.

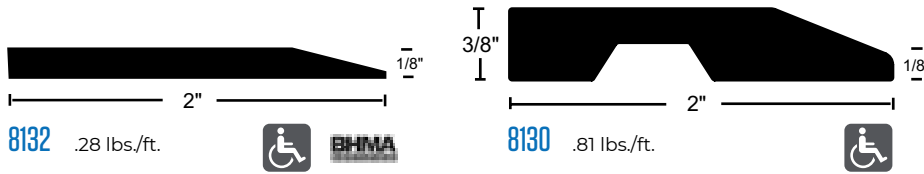

### HALF SADDLE AND EXTENDED WIDTH COMPONENTS





# HALF SADDLE THRESHOLDS

All Products On This Page

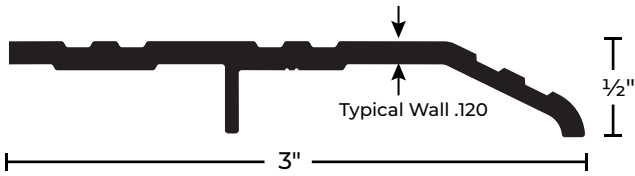

**323** .56 lbs./ft.  
**323DKB** .56 lbs./ft.



## BUMPER SEAL

Seals Against the Door to Provide Weather Resistance

### BUMPER SEAL OPTIONS

- V** Vinyl\*\*
- N** NGP-TPV
- S** Silicone

\*\*Vinyl ("V") Supplied Unless Other Material Specified

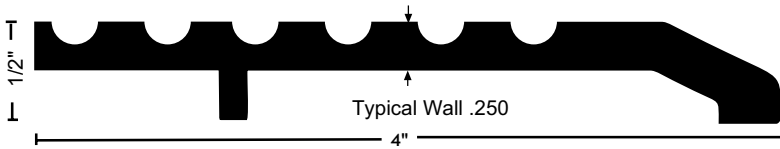

**324** 1.20 lbs./ft.  
**324DKB** 1.20 lbs./ft.

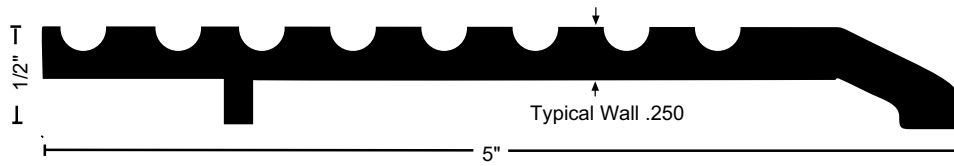

**325** 1.32 lbs./ft.  
**325DKB** 1.32 lbs./ft.

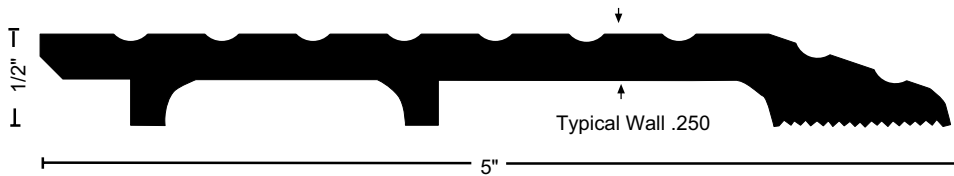

**325HD** 1.65 lbs./ft.  
**325HDDKB** 1.65 lbs./ft.

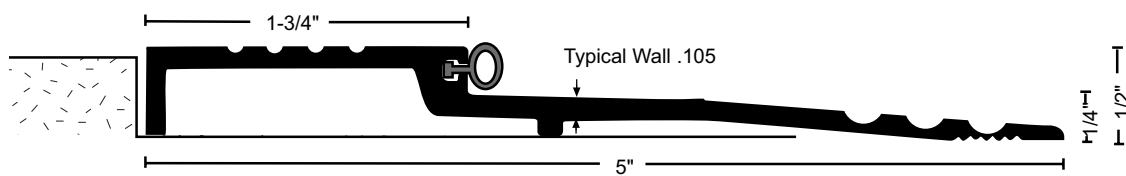

**898** .72 lb./ft.  
**898DKB** .72 lb./ft.



## FASTENERS

- #10 x 1-1/2" FH Zinc-Plated Wood Screws Furnished. Dark Bronze Supplied With DKB.



\* When Installed With the Non-Beveled Edge Flush with Flooring, or Where No Greater Than 1/4" Vertical Rise Occurs

## MATERIALS & FINISHES

- Mill Aluminum
- DKB - Aluminum Dark Bronze/Black Anodized



## OPTIONAL SIA SLIP-RESISTANT FINISH

For Use in Areas Where Conditions Can Be Hazardous and Safety Is a Priority.

# HALF SADDLE THRESHOLDS

## HALF SADDLE AND EXTENDED WIDTH COMPONENTS

All Products On This Page

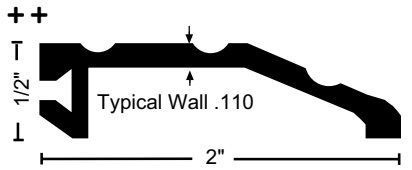

**321** .34 lbs./ft.  
**321DKB** .34 lbs./ft.

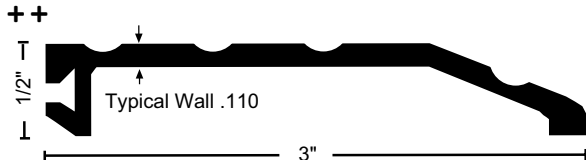

**322** .48 lbs./ft.  
**322DKB** .48 lbs./ft.

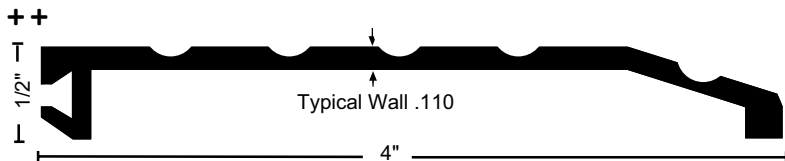

**327** .60 lbs./ft.  
**327DKB** .60 lbs./ft.

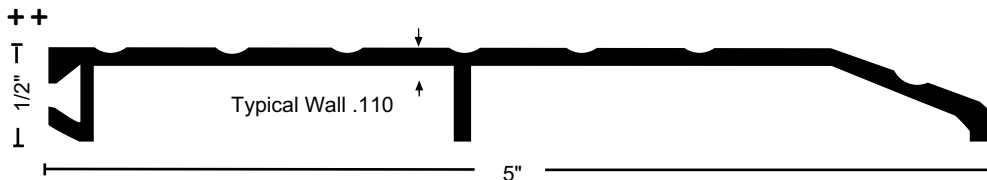

**350** .83 lbs./ft.  
**350DKB** .83 lbs./ft.

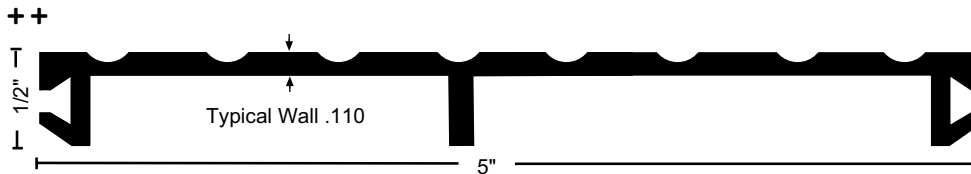

**355** .79 lbs./ft.  
**355DKB** .79 lbs./ft.

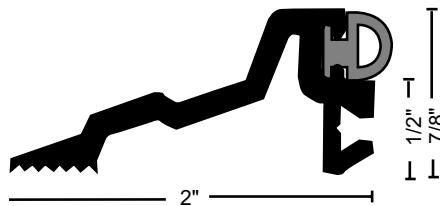

**884B/S** .48 lbs./ft.  
**884B/SDKB** .48 lbs./ft.



### MATERIALS & FINISHES

- Mill Aluminum
- DKB - Aluminum Dark Bronze/Black Anodized



### OPTIONAL SIA SLIP-RESISTANT FINISH

For Use in Areas Where Conditions Can Be Hazardous and Safety Is a Priority.

### FASTENERS

- #10 x 1-1/2" FH Zinc-Plated Wood Screws Furnished. Dark Bronze Supplied With DKB.



\* When Installed With the Non-Beveled Edge Flush with Flooring, or Where No Greater Than 1/4" Vertical Rise Occurs

++ Designed for Thermal Break. Bumper Seal Not Available.



### BUMPER SEAL

Seals Against the Door to Provide Weather Resistance

#### BUMPER SEAL OPTIONS

- V** Vinyl\*\*
- N** NGP-TPV
- S** Gray Silicone

\*\*Vinyl ("V") Supplied Unless Other Material Specified

# EXTENDED WIDTH THRESHOLDS

- Create Wider Saddle or Half Saddle Thresholds, Choosing Components from Previous Page
- Furnished With Aluminum Spline for Field Assembly

## EXAMPLES - HOW TO ORDER:

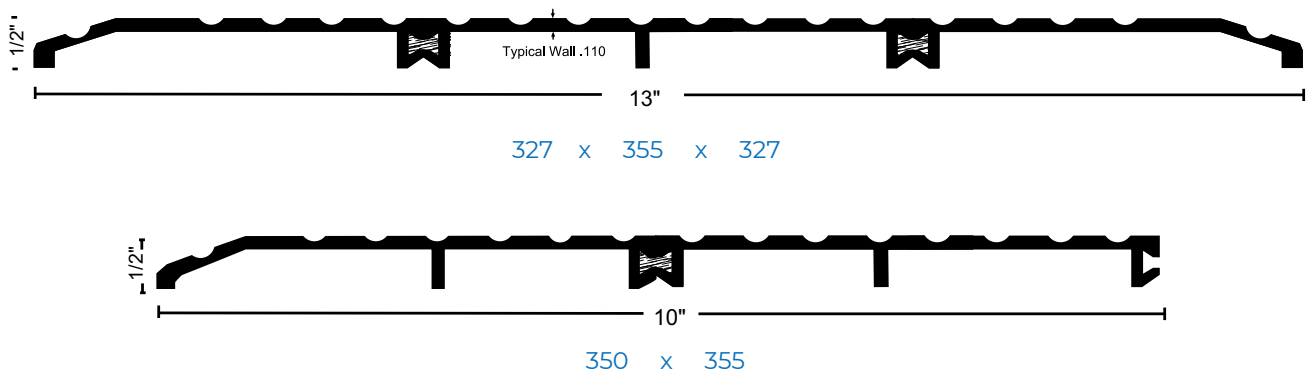

## THERMAL BREAK EXTENDED WIDTH THRESHOLDS

- Create Wider Thermal Break Thresholds For Non-Fire-Rated Applications Using Components from Previous Page
- Furnished With Rigid Thermoplastic Thermal Break Spline for Field Assembly - Indicate "TH" Where Required

## EXAMPLES - HOW TO ORDER:

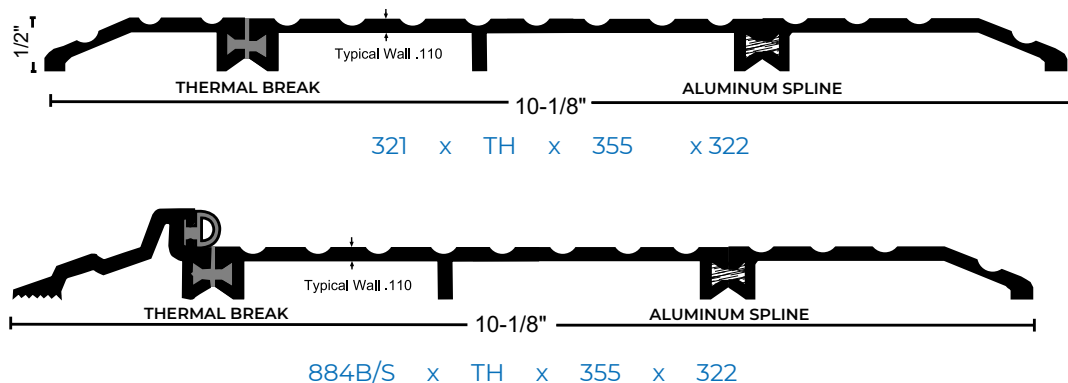

# THERMAL BREAK

## SADDLE THRESHOLDS

All Products On This Page



Thermal Break Thresholds Feature a Rigid Thermoplastic Spline, Creating a Separation to Prevent the Transfer of Outside Temperature and Frost Through the Threshold.

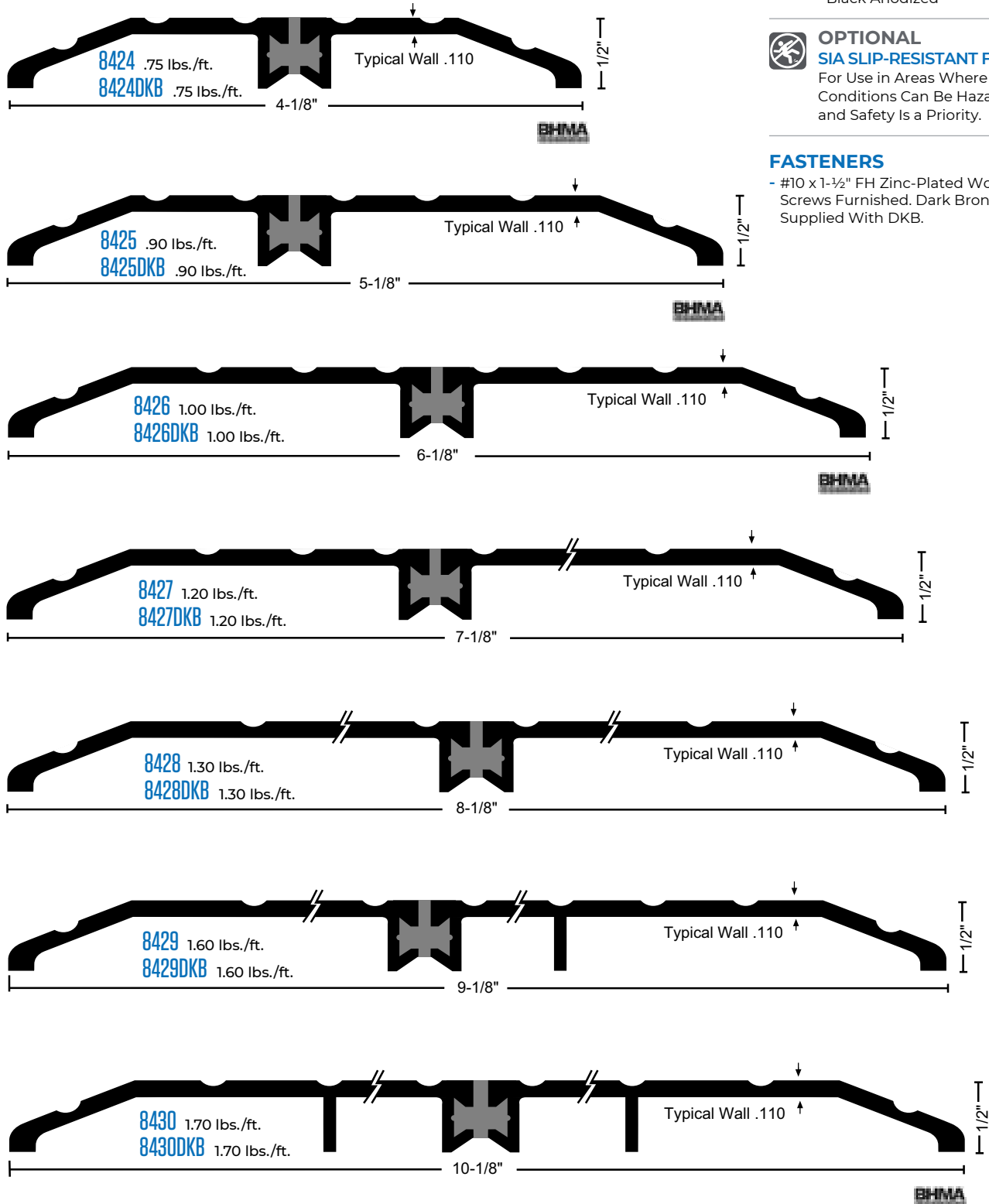

### MATERIALS & FINISHES

- Mill Aluminum
- DKB - Aluminum Dark Bronze/Black Anodized



### OPTIONAL SIA SLIP-RESISTANT FINISH

For Use in Areas Where Conditions Can Be Hazardous and Safety is a Priority.

### FASTENERS

- #10 x 1-1/2" FH Zinc-Plated Wood Screws Furnished. Dark Bronze Supplied With DKB.

# THERMAL BREAK

## SADDLE THRESHOLDS

All Products On This Page



Thermal Break Thresholds Feature a Rigid Thermoplastic Spline, Creating a Separation to Prevent the Transfer of Outside Temperature and Frost Through the Threshold.

### MATERIALS & FINISHES

- Mill Aluminum
- DKB - Aluminum Dark Bronze/Black Anodized



### OPTIONAL SIA SLIP-RESISTANT FINISH

For Use in Areas Where Conditions Can Be Hazardous and Safety Is a Priority.

### FASTENERS

- #10 x 1-1/2" FH Zinc-Plated Wood Screws Furnished. Dark Bronze Supplied With DKB.

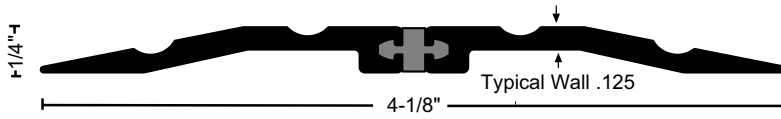

**8413** .57 lbs./ft.  
**8413DKB** .57 lbs./ft.

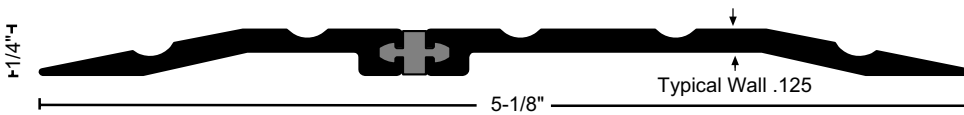

**8513** .70 lbs./ft.  
**8513DKB** .70 lbs./ft.

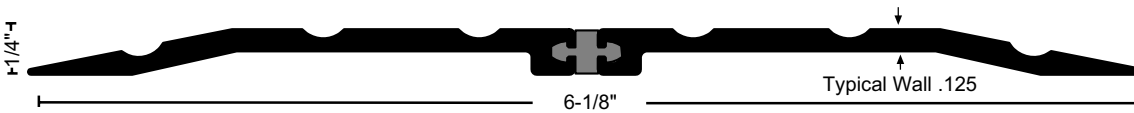

**8613** .83 lbs./ft.  
**8613DKB** .83 lbs./ft.

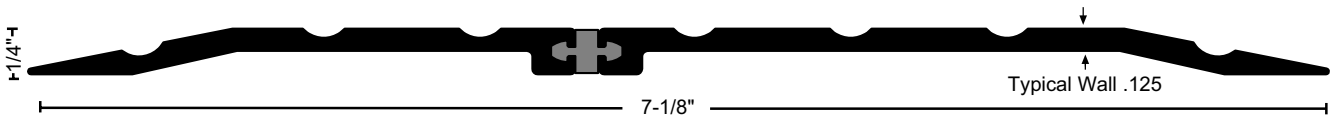

**8713** .97 lbs./ft.  
**8713DKB** .97 lbs./ft.

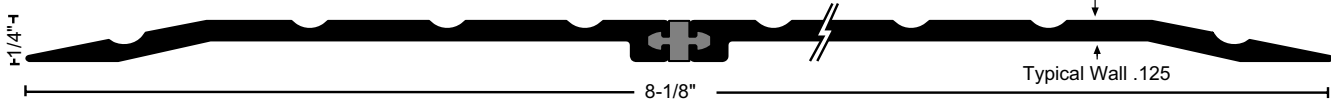

**8813** 1.11 lbs./ft.  
**8813DKB** 1.11 lbs./ft.

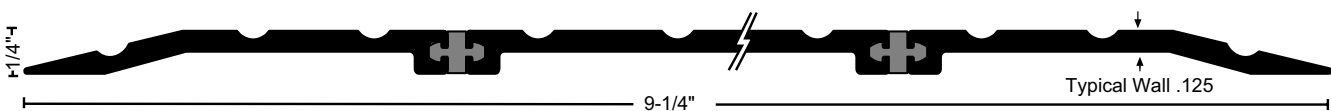

**8913** 1.29 lbs./ft.  
**8913DKB** 1.29 lbs./ft.

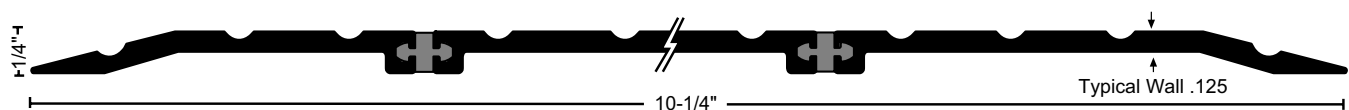

**8013** 1.42 lbs./ft.  
**8013DKB** 1.42 lbs./ft.

# THERMAL BREAK

## SADDLE AND BUMPER SEAL THRESHOLDS

All Products On This Page



### THERMAL BREAK SADDLE THRESHOLDS

Thermal Break Thresholds Feature a Rigid Thermoplastic Spline, Creating a Separation to Prevent the Transfer of Outside Temperature and Frost Through the Threshold.

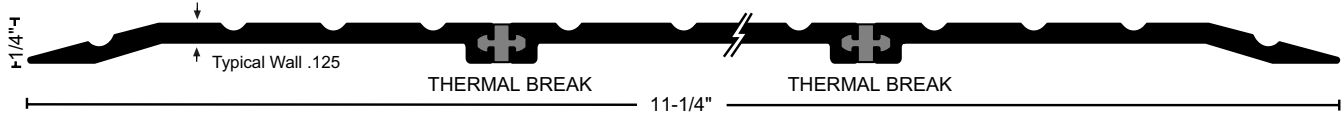

**8113** 1.57 lbs./ft.  
**8113DKB** 1.57 lbs./ft.



**8213** 1.74 lbs./ft.  
**8213DKB** 1.74 lbs./ft.

### THERMAL BREAK BUMPER SEAL THRESHOLDS

Thermal Break Thresholds Feature a Rigid Thermoplastic Spline, Creating a Separation to Prevent the Transfer of Outside Temperature and Frost Through the Threshold.

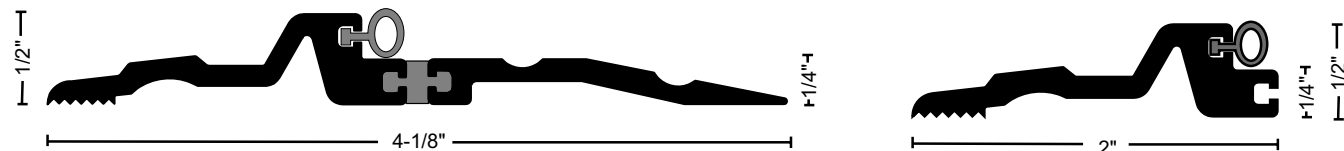

**8433** .69 lbs./ft.  
**8433DKB** .69 lbs./ft.

**8423** .41 lbs./ft.  
**8423DKB** .41 lbs./ft.

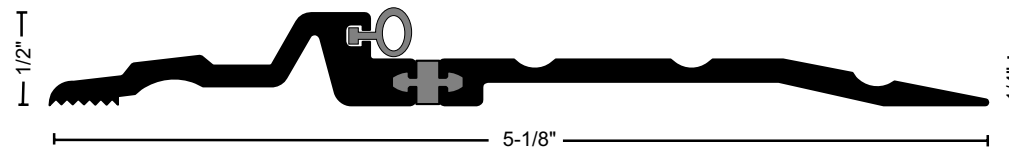

**8533** .83 lbs./ft.  
**8533DKB** .83 lbs./ft.

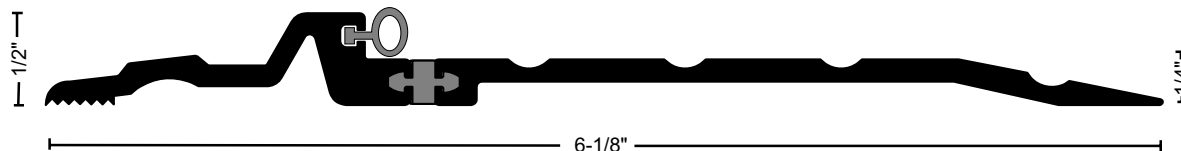

**8633** .97 lbs./ft.  
**8633DKB** .97 lbs./ft.

#### MATERIALS & FINISHES

- Mill Aluminum
- DKB - Aluminum Dark Bronze/Black Anodized



#### OPTIONAL SIA SLIP-RESISTANT FINISH

For Use in Areas Where Conditions Can Be Hazardous and Safety Is a Priority.

#### FASTENERS

- #10 x 1-1/2" FH Zinc-Plated Wood Screws Furnished. Dark Bronze Supplied With DKB.



#### BUMPER SEAL

Seals Against the Door to Provide Weather Resistance

#### BUMPER SEAL OPTIONS

- V** Vinyl\*\*
- N** NGP-TPV
- S** Silicone

\*\*Vinyl ("V") Supplied Unless Other Material Specified

# THERMAL BREAK

## BUMPER SEAL THRESHOLDS

All Products On This Page



### THERMAL BREAK BUMPER SEAL THRESHOLDS

Thermal Break Thresholds Feature a Rigid Thermoplastic Spline, Creating a Separation to Prevent the Transfer of Outside Temperature and Frost Through the Threshold.

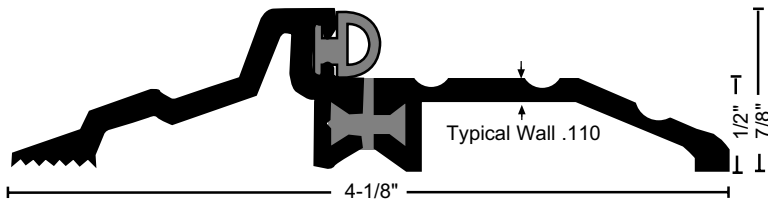

**8434** .82 lbs./ft.  
**8434DKB** .82 lbs./ft.

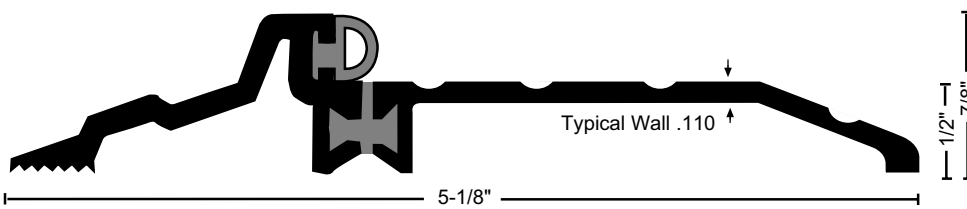

**8435** .95 lbs./ft.  
**8435DKB** .95 lbs./ft.

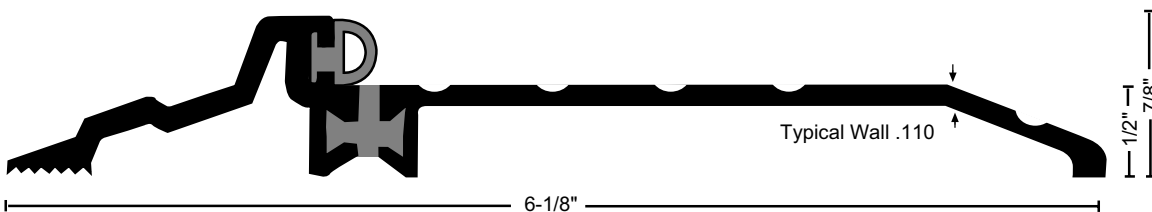

**8436** 1.11 lbs./ft.  
**8436DKB** 1.11 lbs./ft.

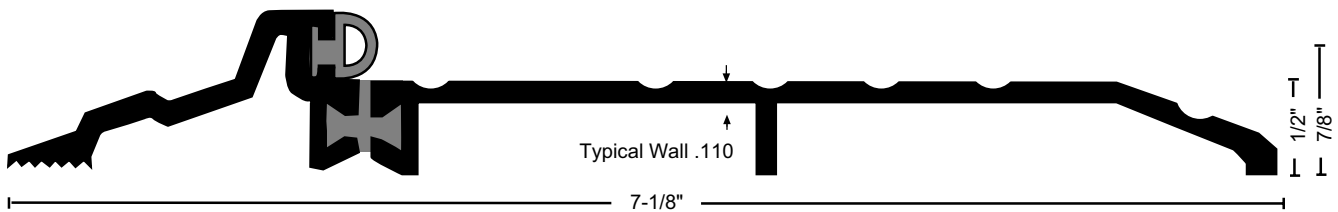

**8437** 1.29 lbs./ft.  
**8437DKB** 1.29 lbs./ft.

**HD BUMPER SEAL**  
 Provides Weather Resistance

BUMPER SEAL OPTIONS	
<b>V</b>	Vinyl**
<b>N</b>	NGP-TPV
<b>S</b>	Silicone

\*\*Vinyl ("V") Supplied Unless Other Material Specified

#### MATERIALS & FINISHES

- Mill Aluminum
- DKB - Aluminum Dark Bronze/Black Anodized



#### OPTIONAL SIA SLIP-RESISTANT FINISH

For Use in Areas Where Conditions Can Be Hazardous and Safety Is a Priority.

#### FASTENERS

- #10 x 1-1/2" FH Zinc-Plated Wood Screws Furnished. Dark Bronze Supplied With DKB.

# EXTENDED WIDTH

## BUMPER SEAL THRESHOLDS

All Products On This Page



### EXTENDED WIDTH BUMPER SEAL THRESHOLDS

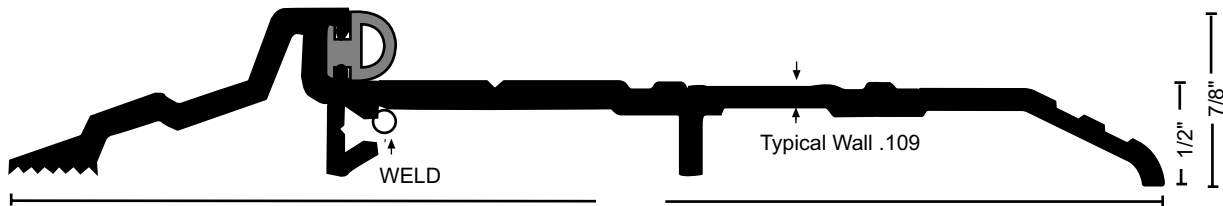

<b>884-6</b>	1.10 lbs./ft.	6"
<b>884-6DKB</b>	1.10 lbs./ft.	
<b>884-7</b>	1.31 lbs./ft.	7"
<b>884-7DKB</b>	1.31 lbs./ft.	
<b>884-8</b>	1.52 lbs./ft.	8"
<b>884-8DKB</b>	1.52 lbs./ft.	

## VINYL TOP THRESHOLDS

## ELEVATORS

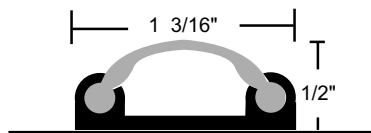

**12V** .31 lbs./ft.  
**12VDKB** .31 lbs./ft.

Elevators Are Used Under Thresholds to Increase the Rise of the Threshold or Accommodate Offset Floor Conditions.



**58** .16 lbs./ft.  
**58DKB** .16 lbs./ft.



#### MATERIALS & FINISHES

- Mill Aluminum
- DKB - Aluminum Dark Bronze/Black Anodized



#### OPTIONAL SIA SLIP-RESISTANT FINISH

For Use in Areas Where Conditions Can Be Hazardous and Safety Is a Priority.

#### FASTENERS

- #10 x 1-1/2" FH Zinc-Plated Wood Screws Furnished. Dark Bronze Supplied With DKB.



#### BUMPER SEAL

Provides Weather Resistance

#### BUMPER SEAL OPTIONS

- V** Vinyl\*\*
- N** NGP-TPV
- S** Silicone

\*\*Vinyl ("V") Supplied Unless Other Material Specified



# ALUMINUM RAMPS

All Products On This Page



Illustrations Shown at 50%  
Slope = 1:12

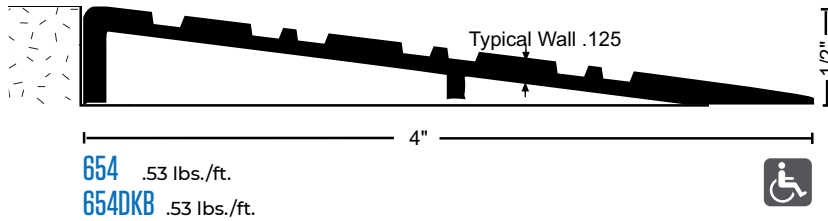

## MATERIALS & FINISHES

- Mill Aluminum
- DKB - Aluminum Dark Bronze/Black Anodized



## OPTIONAL SIA SLIP-RESISTANT FINISH

For Use in Areas Where Conditions Can Be Hazardous and Safety Is a Priority.

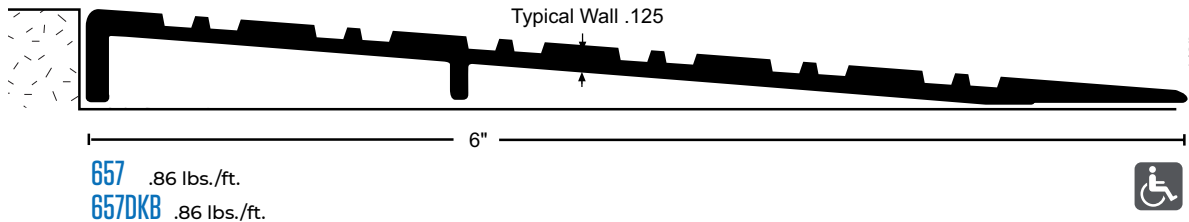

# INTERLOCKING RUBBER RAMPS

- Supplied With Beveled Ends (End Slope = 1:2). Specify if Straight Cut Is Required.
- Rubber Ramp Sections May Be Combined With Aluminum Ramp Components for Higher Rises, or With 6" Flat Aluminum Interlocking Threshold #957 for Offset Conditions.
- Black Silicone Adhesive Available to Secure Ramps Without Fasteners. Specify RR5007BL, Each Tube Will Secure 2 Ramps 12" Wide X 36" Long (6 Square Feet).

Illustrations Shown at 50%  
Slope = 1:12

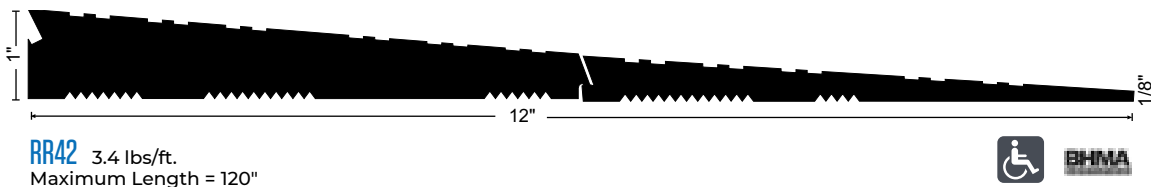
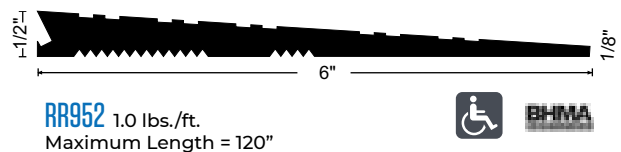

# INTERLOCKING RAMPS

ADA COMPLIANT

All Products On This Page



Illustrations Shown at 50%  
Slope = 1:12

**R50** .94 lbs./ft.  
**R50DKB** .94 lbs./ft.

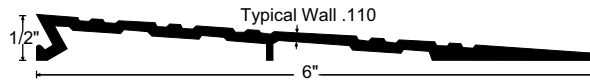

**R75** 1.63 lbs./ft.  
**R75DKB** 1.63 lbs./ft.

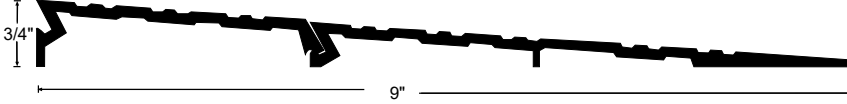

**R100** 2.06 lbs./ft.  
**R100DKB** 2.06 lbs./ft.

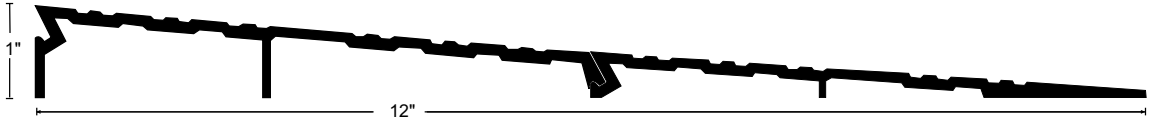

**R125** 2.77 lbs./ft.  
**R125DKB** 2.77 lbs./ft.

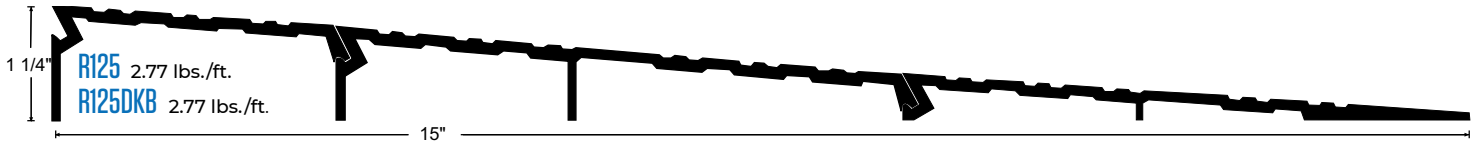

**R150** 3.82 lbs./ft.  
**R150DKB** 3.82 lbs./ft.

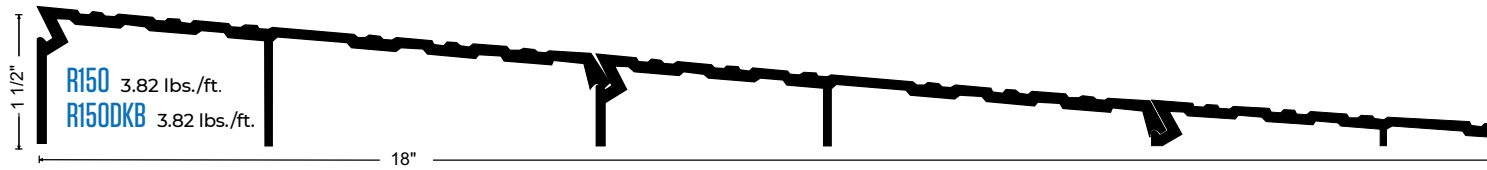

**R175** 4.53 lbs./ft.  
**R175DKB** 4.53 lbs./ft.

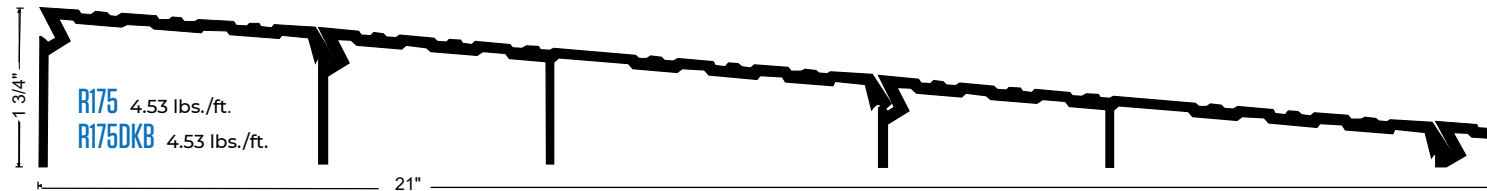

**R200** 5.58 lbs./ft.  
**R200DKB** 5.58 lbs./ft.

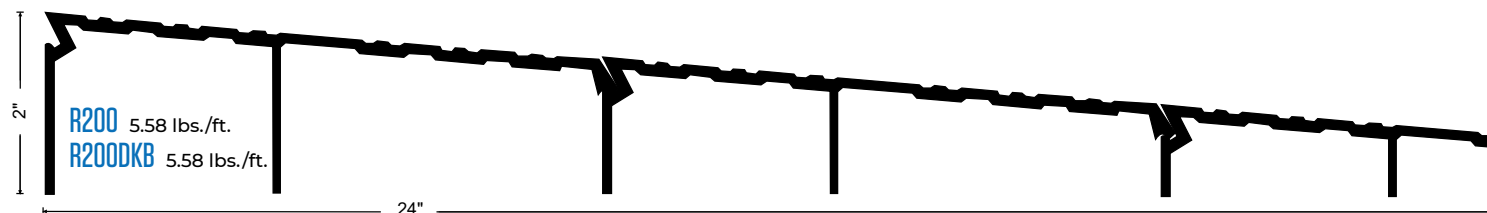

**R225** 6.37 lbs./ft.  
**R225DKB** 6.37 lbs./ft.

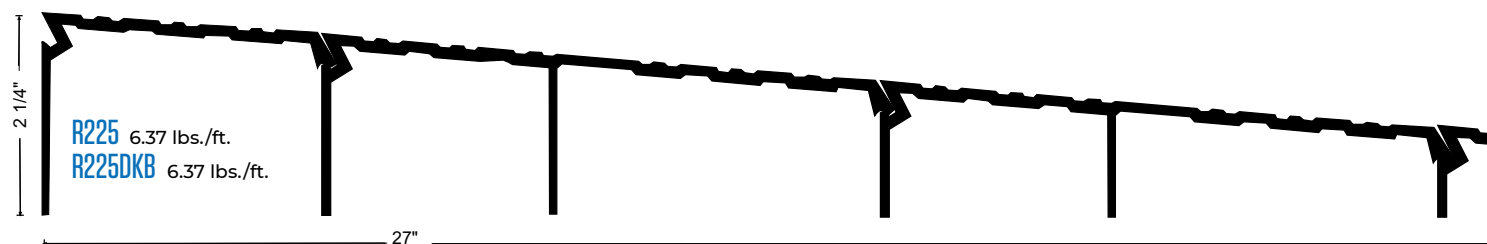

**R250** 7.34 lbs./ft.  
**R250DKB** 7.34 lbs./ft.

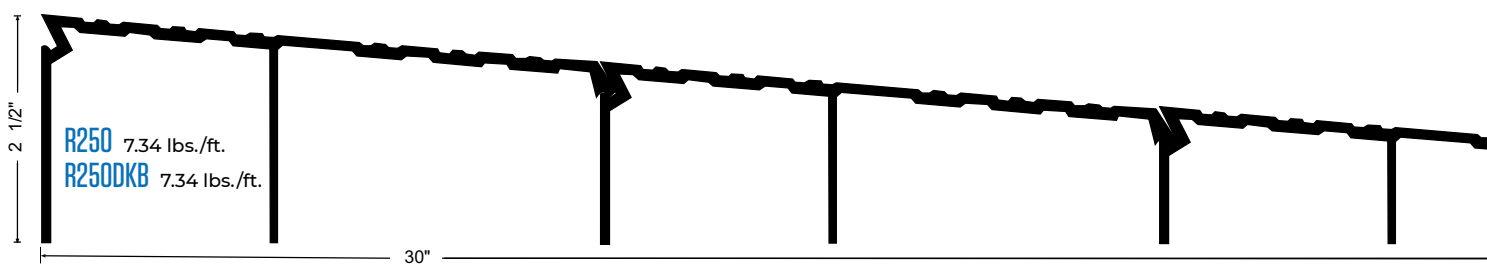

# INTERLOCKING RAMPS

ADA COMPLIANT

All Products On This Page



Illustrations Shown at 50%

## RETURN CLOSED ENDS FOR RAMPS

Return Closed Ends Provide an Attractive Finished Appearance. They Are Available in Several Lengths and Can Be Field Trimmed to Accommodate Any Size Ramp Assembly.

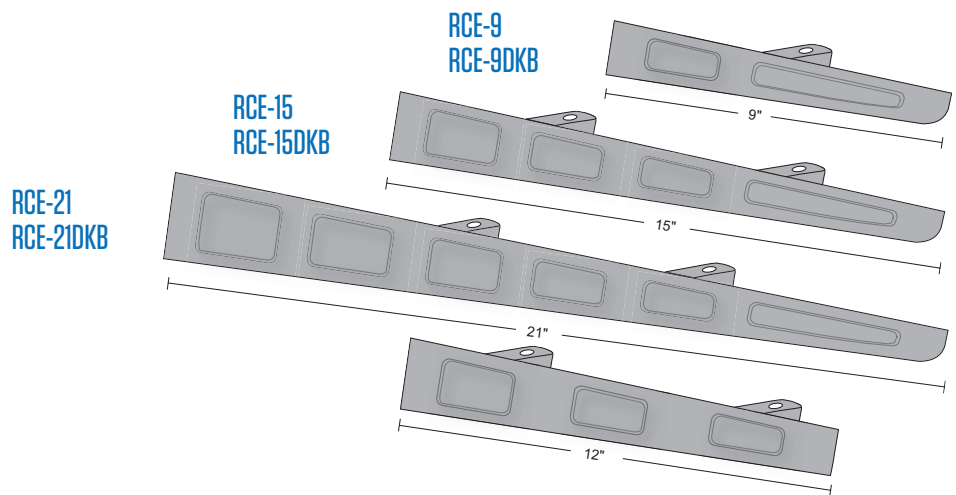
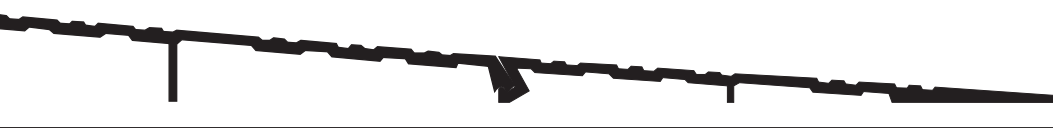

RCE-30 (Includes RCE-21 + 12" Extension)  
RCE-30DKB (Includes RCE-21 + 12" Extension)

### MATERIALS & FINISHES

- Mill Aluminum
- DKB - Aluminum Dark Bronze/Black Anodized



### OPTIONAL SIA SLIP-RESISTANT FINISH

For Use in Areas Where Conditions Can Be Hazardous and Safety Is a Priority.

# INTERLOCKING OFFSET RAMPS

ADA COMPLIANT

All Products On This Page



Illustrations Shown at 50%  
Slope = 1:12

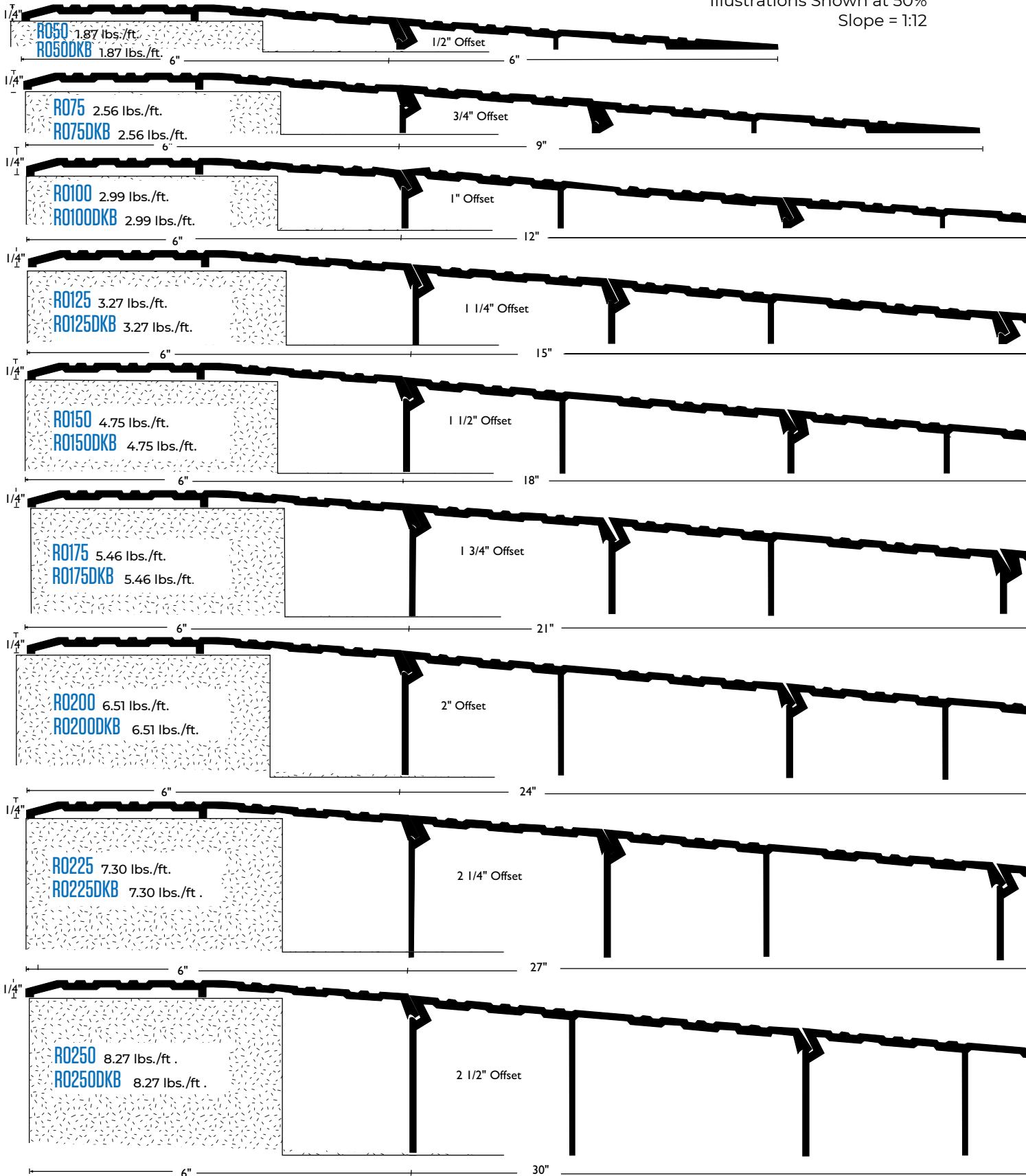

# INTERLOCKING OFFSET RAMPS

ADA COMPLIANT

All Products On This Page



## RETURN CLOSED ENDS FOR RAMPS

Return Closed Ends Provide an Attractive Finished Appearance. They Are Available in Several Lengths and Can Be Field Trimmed to Accommodate Any Size Ramp Assembly.

Illustrations Shown at 50%  
Slope = 1:12

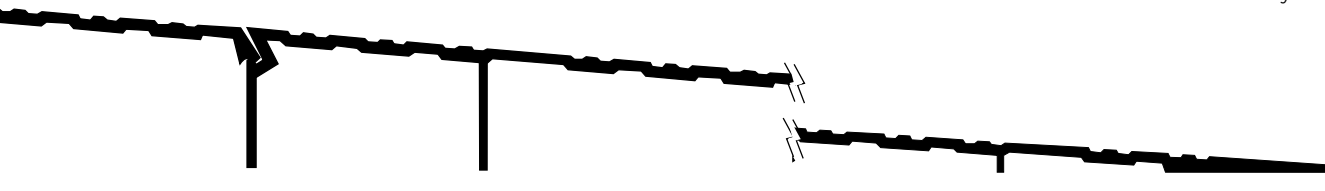
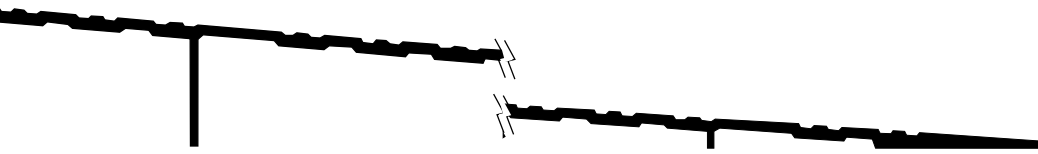
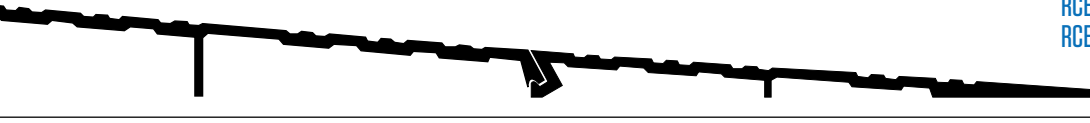

RCE-9  
RCE-9DKB

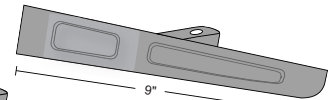

RCE-15  
RCE-15DKB

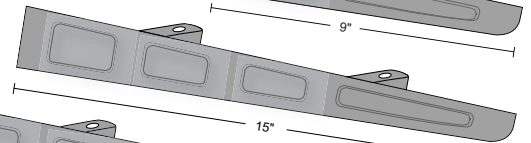

RCE-21  
RCE-21DKB

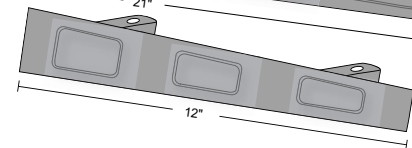
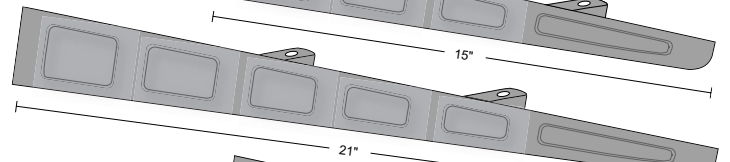

RCE-30 (Includes RCE-21 + 12" Extension)  
RCE-30DKB (Includes RCE-21 + 12" Extension)

### MATERIALS & FINISHES

- Mill Aluminum
- DKB - Aluminum Dark Bronze/Black Anodized



### OPTIONAL SIA SLIP-RESISTANT FINISH

For Use in Areas Where Conditions Can Be Hazardous and Safety Is a Priority.

# INTERLOCKING RAMP

## COMPONENTS

All Products On This Page



### RAMPS COMPLY WITH

- ▶ ADA Standards for Accessible Design
- ▶ ICC/ANSI A117.1 Accessible and Usable Buildings and Facilities

### REQUIREMENTS:

- ▶ Maximum Threshold Height = 1/2"
- ▶ Thresholds Above 1/4" Must Be Beveled With a Slope No Greater Than 1:2
- ▶ Height Changes Over 1/2" Require Use of a Ramp With Slope Not Steeper Than 1:12

Illustrations Shown at 50%



\* When Installed as Part of an Interlocking Ramp Assembly.

### MATERIALS & FINISHES

- Mill Aluminum
- DKB - Aluminum Dark Bronze/Black Anodized

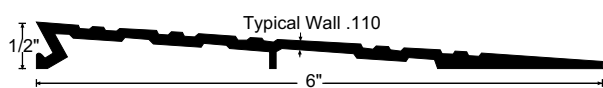

**R50** .94 lbs./ft.  
**R50DKB** .94 lbs./ft.



**953** .69 lbs./ft.  
**953DKB** .69 lbs./ft.

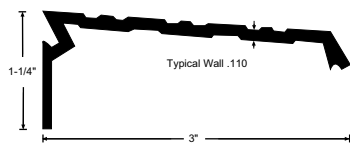

**955** .71 lbs./ft.  
**955DKB** .71 lbs./ft.

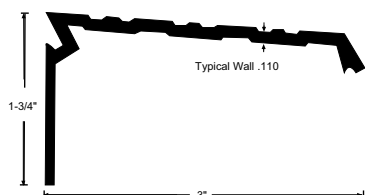

**951** .71 lbs./ft.  
**951DKB** .71 lbs./ft.

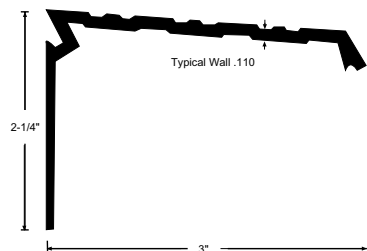

**959** .79 lbs./ft.  
**959DKB** .79 lbs./ft.

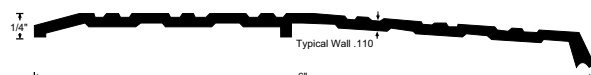

**957** .93 lbs./ft.  
**957DKB** .93 lbs./ft.

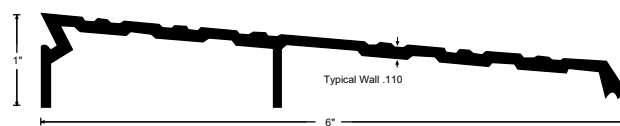

**954** 1.12 lbs./ft.  
**954DKB** 1.12 lbs./ft.

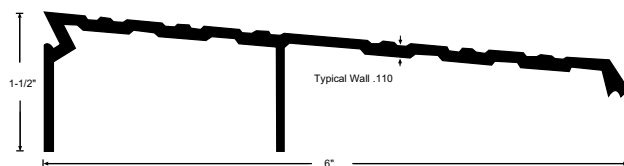

**962** 1.23 lbs./ft.  
**962DKB** 1.23 lbs./ft.

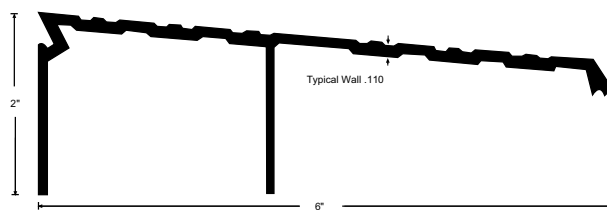

**961** 1.34 lbs./ft.  
**961DKB** 1.34 lbs./ft.

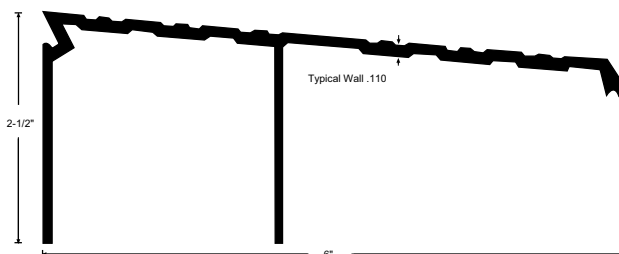

**960** 1.76 lbs./ft.  
**960DKB** 1.76 lbs./ft.

# CUSTOM FABRICATED THRESHOLDS

All Products On This Page



\*Exception(s): 8168N, 8163, 8164, 8167  
Illustrations Shown at 50%

Choose From Various Height and Width Components to Build Custom Thresholds to Meet Special Job Requirements. See the Custom Fabricated Threshold Example Illustrated on Page T5. For Assistance, Contact Our Tech Support Team.

Select the Proper Height Edge Components. Select the Appropriate Center Plates to Construct the Width Needed. Plates May Be Butted Together or Ripped to Make Specific Widths. Support Joints and Wider Spans With Bar Supports.

Threshold Assembly Plates May Be Used Fluted or Smooth Side Up. SIA Slip-Resistant Finish Can Be Applied to All Parts.

Threshold Assembly Components May Be Ordered Separately for Field Assembly or Welded into One-Piece Units in Our Custom Fabrication Shop. They Are Supplied Undrilled Unless a Template Is Provided. Ripping and Beveling Options Are Available. All Custom Fabricated Assemblies Have a Tolerance of +/- 1/16".

If a Welded Assembly Is Desired, Specify "Welded".

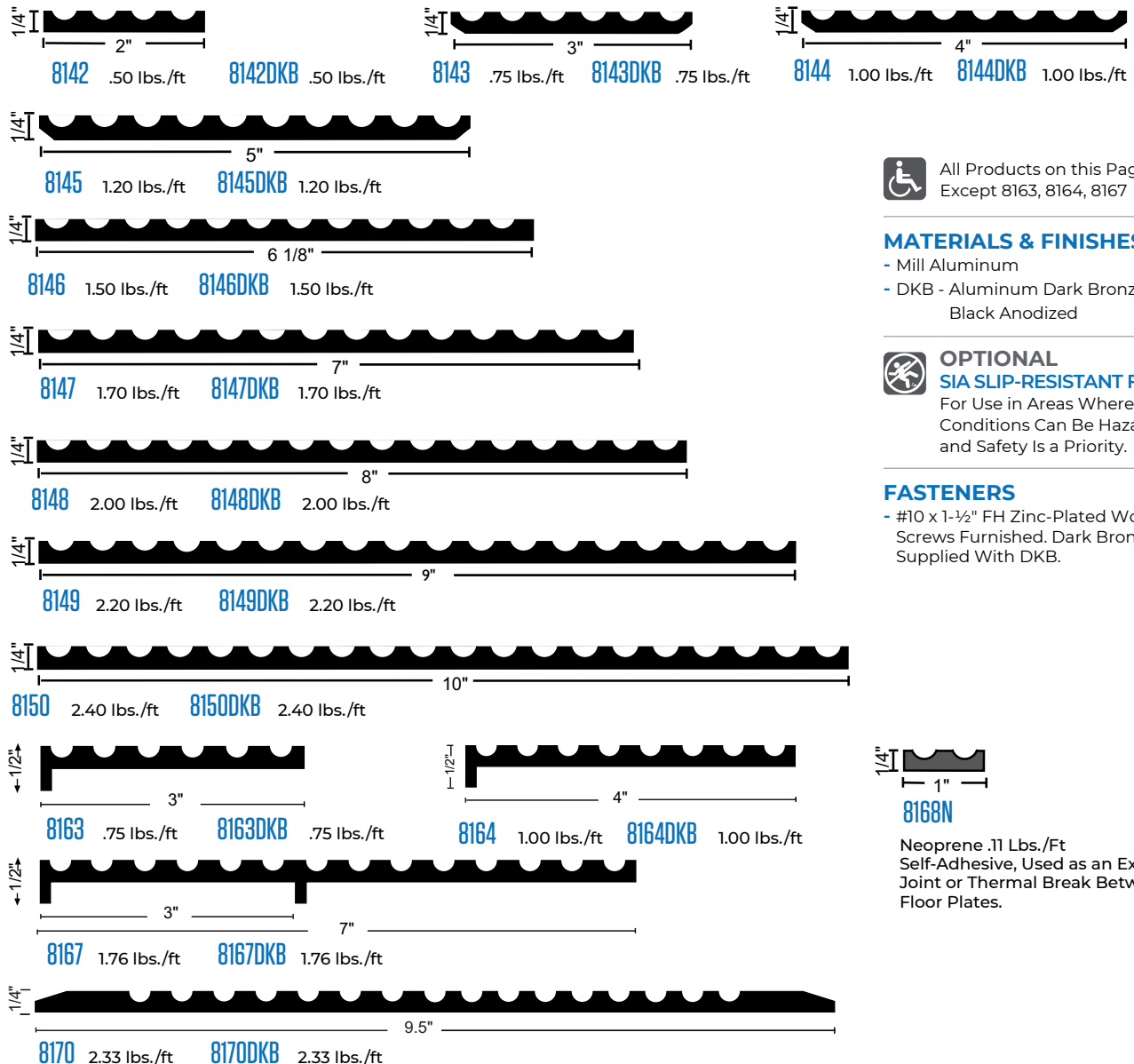

All Products on this Page Except 8163, 8164, 8167

### MATERIALS & FINISHES

- Mill Aluminum
- DKB - Aluminum Dark Bronze/Black Anodized

### OPTIONAL SIA SLIP-RESISTANT FINISH

For Use in Areas Where Conditions Can Be Hazardous and Safety Is a Priority.

### FASTENERS

- #10 x 1-1/2" FH Zinc-Plated Wood Screws Furnished. Dark Bronze Supplied With DKB.

# EDGE COMPONENTS

All Products On This Page



\*Exception(s): 8134

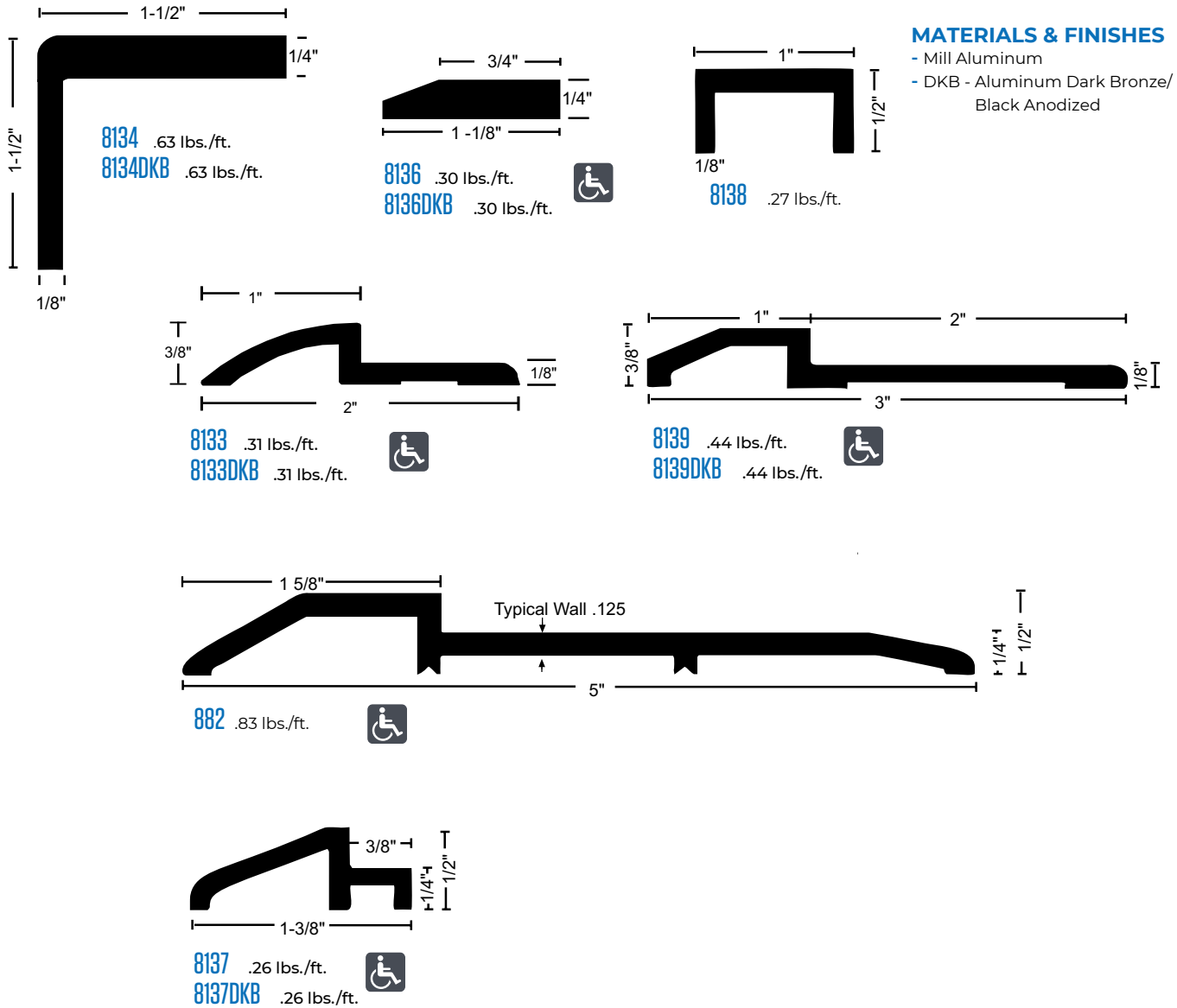

# BAR SUPPORTS

Used as Support Under Threshold Assemblies





# ALUMINUM COVER PLATES

All Products On This Page



- ▶ Great for Expansion Joint Covers or Anywhere Extra Width and Strength Are Required
- ▶ Cover Plates Are Made to Order; Non-Returnable / Non-Cancelable Once Fabricated
- ▶ Manufactured Through a Rolled Process Providing Extra Durability
- ▶ PVC Coating Applied to Protect the Finish During Shipping and Installation
- ▶ Minimum Width 2" on 818, 3" on 814 and 4" on 838
- ▶ Edges Are Beveled Unless Otherwise Specified
- ▶ Furnished Undrilled Although Custom Drilling Is Available to Your Detail
- ▶ #10 X 1½" Zinc-Plated Wood Screws Furnished

## MATERIALS & FINISHES

- Mill Aluminum
- DKB - Aluminum Matte Black Powder Coated



## OPTIONAL SIA SLIP-RESISTANT FINISH

For Use in Areas Where Conditions Can Be Hazardous and Safety Is a Priority.

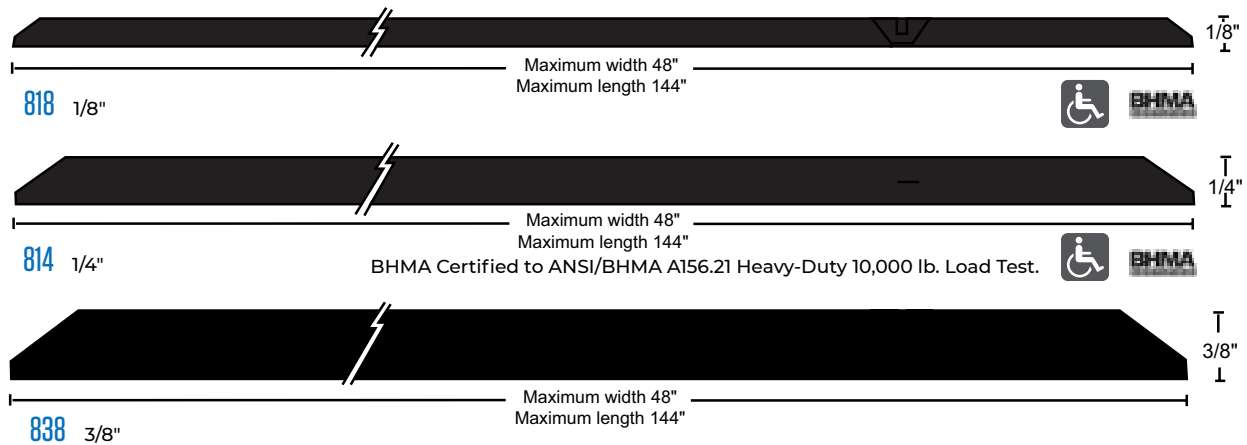

# STAINLESS STEEL COVER PLATES

- ▶ PVC Coating Applied to Protect the Finish During Shipping and Installation
- ▶ Square Cut Edges Standard. Specify if Beveled Edge Is Required
- ▶ Furnished Undrilled Although Custom Drilling Is Available to Your Detail
- ▶ Minimum Width 3" on 818SS and 4" on 814SS
- ▶ #10 X 1½" Stainless Steel Wood Screws Furnished

## MATERIALS & FINISHES

#304 Stainless Steel, Mill Finish

### Optional Finishes

- POL - Polished US32, 629
- BRUSHED - Brushed US32D, 630



## OPTIONAL SIA SLIP-RESISTANT FINISH

For Use in Areas Where Conditions Can Be Hazardous and Safety Is a Priority.

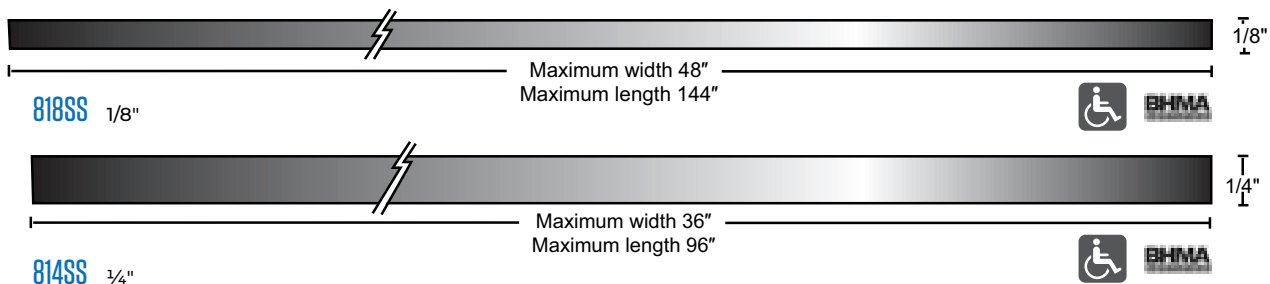
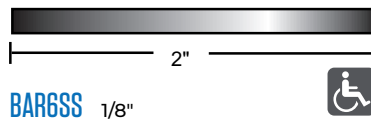

# FLOOR CLOSER THRESHOLDS

Thresholds Can Be Fabricated for Use With Any Floor Closer. They Are Available in Aluminum, Bronze, or Stainless Steel in Several Finishes Including SIA Slip-Resistant Finish.

## Specify When Ordering

- ▶ Type x Number (i.e., Type 3 X 427E)
- ▶ Material and Finish
- ▶ Door Opening Width
- ▶ Door Thickness if Other Than 1 3/4"
- ▶ Handing (Door Handing)
- ▶ Closer Manufacturer
- ▶ Closer Model Number

## TYPE 1, 3 & 4 ALUMINUM

1/2" x 7"	427E
1/2" x 8"	428E
3/4" x 7"	713
3/4" x 8"	813
1/2" x 9"	429E
1/2" x 10"	430E
3/4" x 9"	913
3/4" x 10"	1013

## TYPE 5 ALUMINUM

1/2" x 7" x 4"	427E x 424E
3/4" x 7" x 4"	713 x 413
1/2" x 8" x 5"	428E x 425E
3/4" x 8" x 5"	813 x 513

## ARCHITECTURAL BRONZE

1/2" x 7"	427BR
1/2" x 8"	428BR
3/4" x 7"	713BR
3/4" x 8"	813BR

## ARCHITECTURAL BRONZE

1/2" x 7" x 4"	427BR x 424BR
1/2" x 8" x 5"	428BR x 425BR
3/4" x 8" x 5"	813BR x 513BR

Other Thresholds and Custom Assemblies May Be Prepped for Floor Closers. Consult Factory for Custom Applications.

## Special Finishes Available

- ▶ Polished, Suffix "POL"
- ▶ Dark Oxidized Bronze US10B, Suffix "DKB"
- ▶ SIA Slip-Resistant Finish, Suffix "SIA"



## MATERIALS & FINISHES

- Mill Aluminum
- DKB - Aluminum Dark Bronze/Black Anodized

## OFFSET HUNG

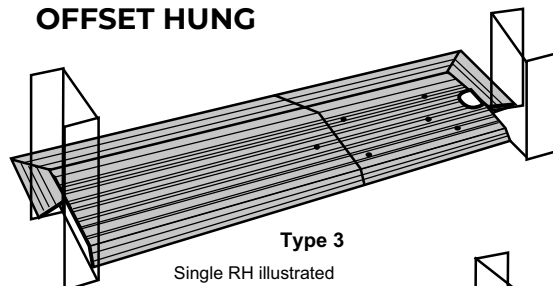

**Type 3**  
Single RH illustrated

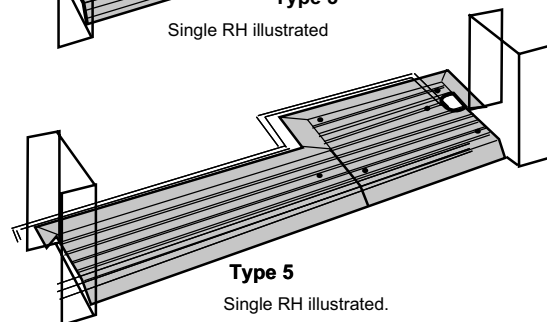

**Type 5**  
Single RH illustrated.

## CENTER HUNG

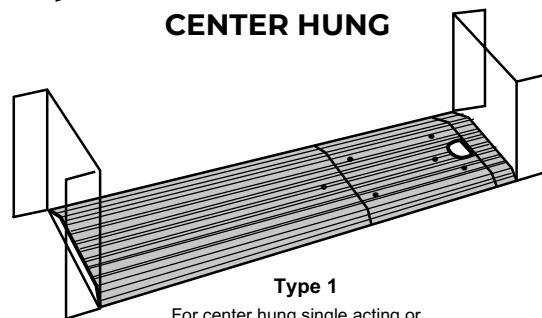

**Type 1**  
For center hung single acting or double acting. Ends not mitered.

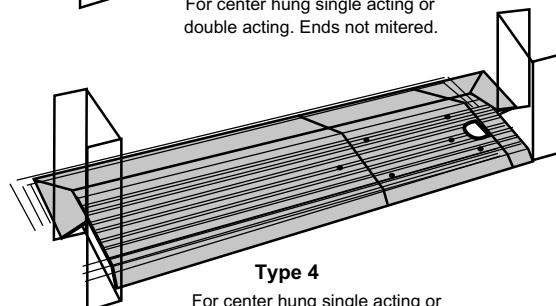

**Type 4**  
For center hung single acting or double acting. Both ends mitered.

## Stainless Steel Available

- ▶ Specify Type (1, 3 or 4) x Stainless Steel Threshold Model Number

## MATERIALS & FINISHES

#304 Stainless Steel, Mill Finish

### Optional Finishes

- POL - Polished US32, 629
- BRUSHED - Brushed US32D, 630

# FLOOR CLOSER THRESHOLDS

All Products On This Page



## MATERIALS & FINISHES

- Mill Aluminum
- DKB - Aluminum Dark Bronze/Black Anodized



## OPTIONAL SIA SLIP-RESISTANT FINISH

For Use in Areas Where Conditions Can Be Hazardous and Safety Is a Priority.

## FASTENERS

- #10 x 1-1/2" FH Zinc-Plated Wood Screws Furnished. Dark Bronze Supplied With DKB.

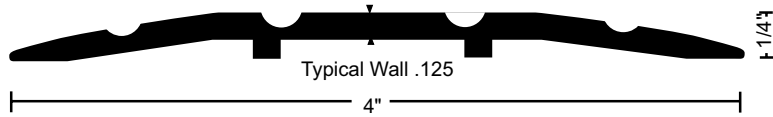

**413** .53 lbs./ft.  
**413DKB** .53 lbs./ft.

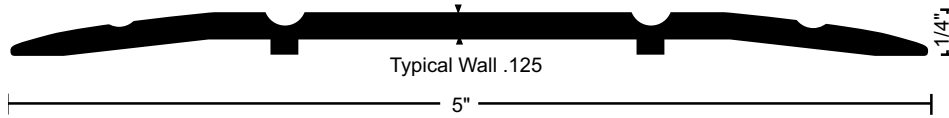

**513** .68 lbs./ft.  
**513DKB** .68 lbs./ft.

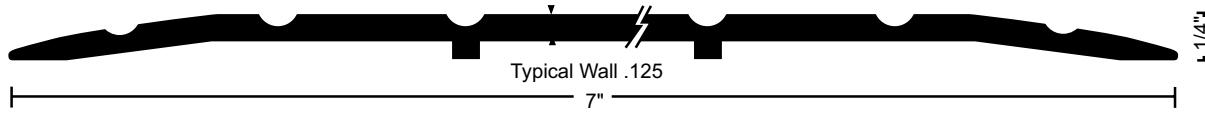

**713** 1.01 lbs./ft.  
**713DKB** 1.01 lbs./ft.

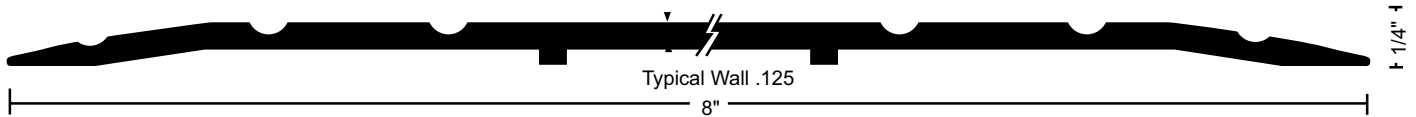

**813** 1.20 lbs./ft.  
**813DKB** 1.20 lbs./ft.

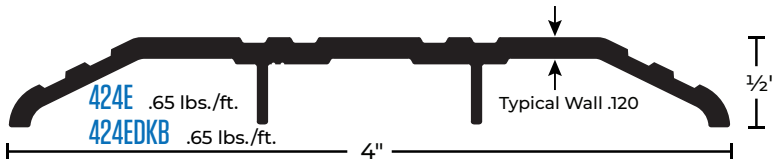

**424E** .65 lbs./ft.  
**424EDKB** .65 lbs./ft.

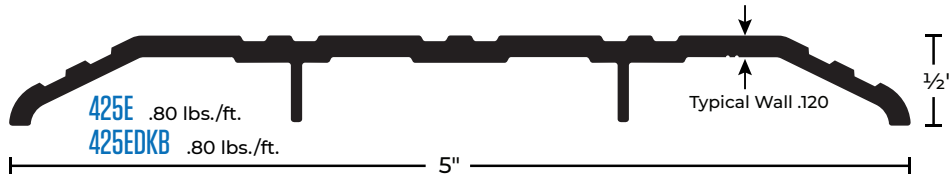

**425E** .80 lbs./ft.  
**425EDKB** .80 lbs./ft.

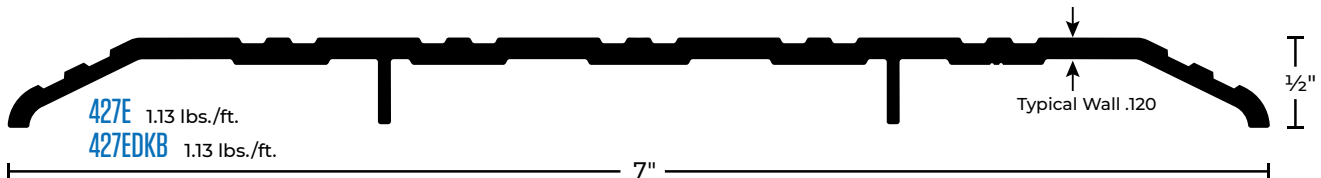

**427E** 1.13 lbs./ft.  
**427EDKB** 1.13 lbs./ft.

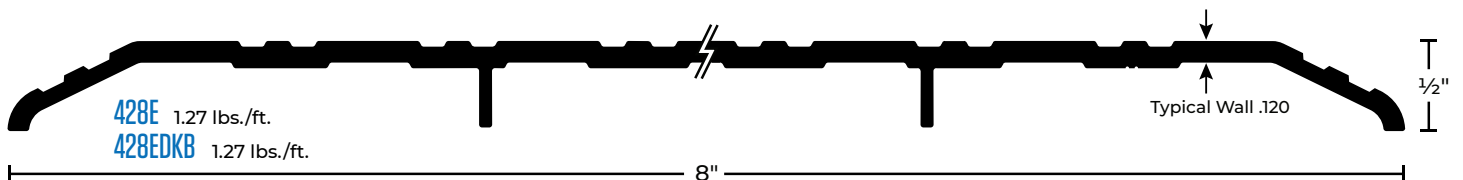

**428E** 1.27 lbs./ft.  
**428EDKB** 1.27 lbs./ft.

# STAINLESS STEEL

## 1/4" SADDLE THRESHOLDS

All Products On This Page



- Widths and Heights Other Than Shown Are Available Upon Request
- Return Closed Ends Are Available - See Page T5
- Stainless Steel Thresholds Are Type #304, Mill Finish

### MATERIALS & FINISHES

#304 Stainless Steel, Mill Finish

#### Optional Finishes

- POL - Polished US32, 629
- BRUSHED - Brushed US32D, 630



### OPTIONAL SIA SLIP-RESISTANT FINISH

For Use in Areas Where Conditions Can Be Hazardous and Safety Is a Priority.

### FASTENERS

- #10 x 1-1/2" FH Stainless Steel Wood Screws

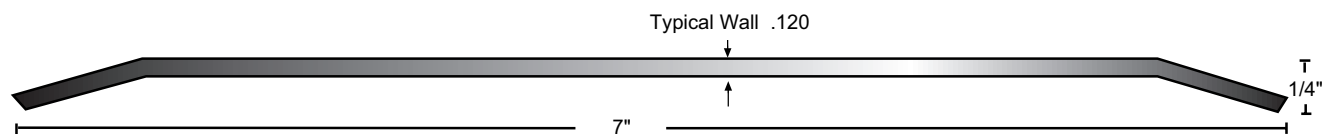
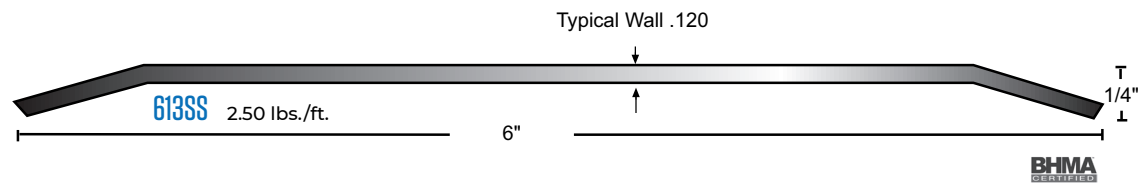
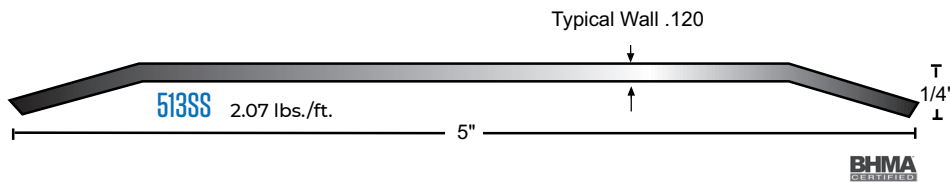
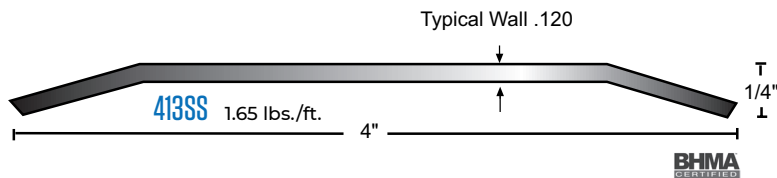

<b>713SS</b>	2.95 lbs./ft.	7"
<b>813SS</b>	3.38 lbs./ft.	8"
<b>913SS</b>	3.81 lbs./ft.	9"
<b>1013SS</b>	4.25 lbs./ft.	10"

# STAINLESS STEEL

## 1/2" SADDLE THRESHOLDS

All Products On This Page



- Widths and Heights Other Than Shown Are Available Upon Request
- Return Closed Ends Are Available - See Page T5
- Stainless Steel Thresholds Are Type #304, Mill Finish



### 412SS

Stainless Steel Saddle Threshold, 1/2" x 4"

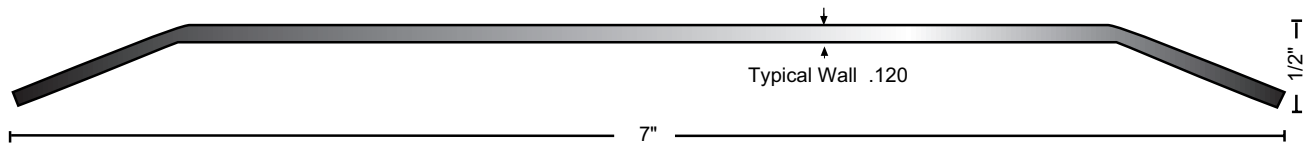
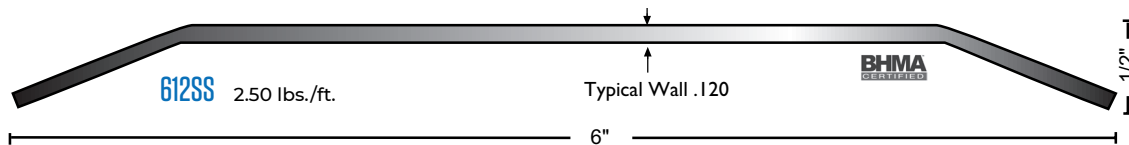
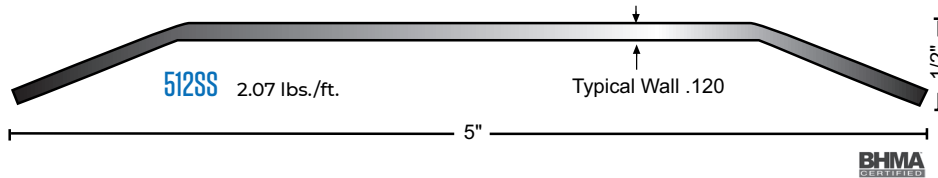
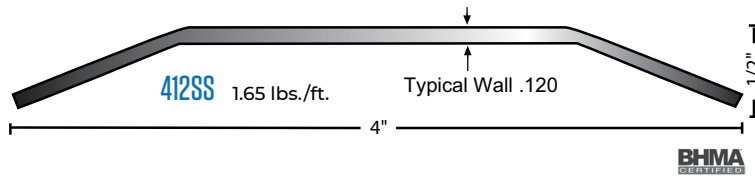

712SS	2.95 lbs./ft.	7"
812SS	3.38 lbs./ft.	8"
912SS	3.81 lbs./ft.	9"
1012SS	4.25 lbs./ft.	10"

### MATERIALS & FINISHES

#304 Stainless Steel, Mill Finish

#### Optional Finishes

- POL - Polished US32, 629
- BRUSHED - Brushed US32D, 630



### OPTIONAL SIA SLIP-RESISTANT FINISH

For Use in Areas Where Conditions Can Be Hazardous and Safety Is a Priority.

### FASTENERS

- #10 x 1-1/2" FH Stainless Steel Wood Screws

# STAINLESS STEEL

## BUMPER SEAL THRESHOLDS

All Products On This Page

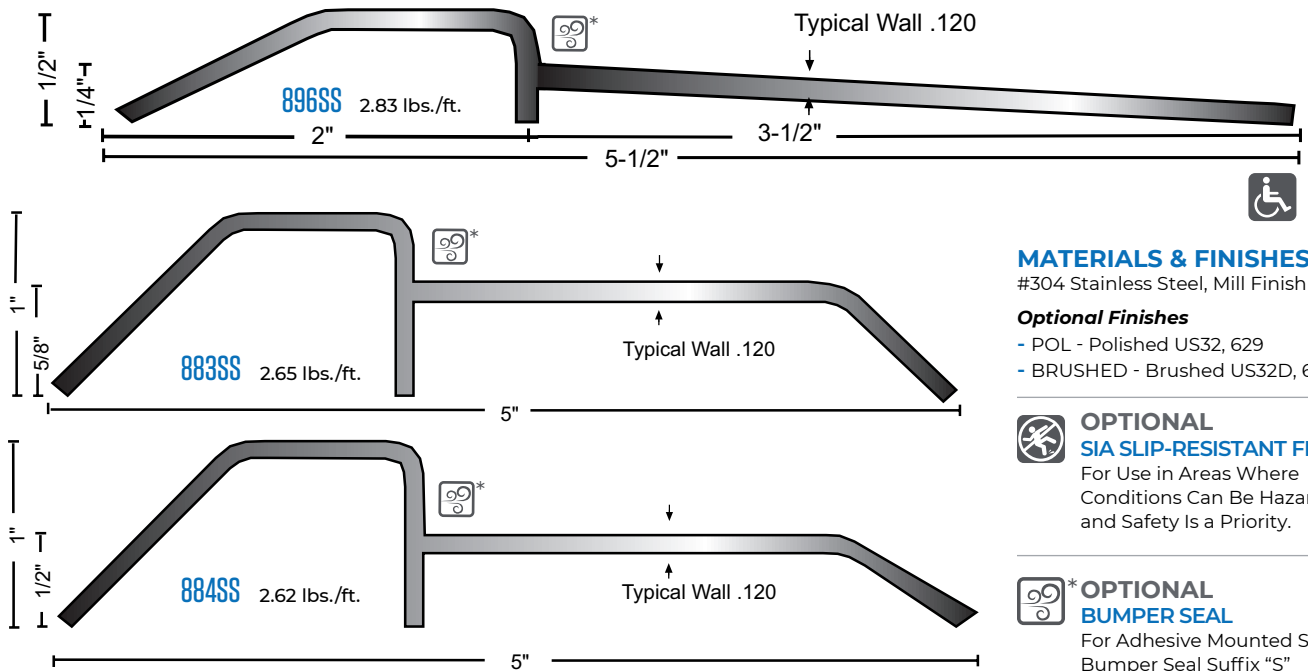

### MATERIALS & FINISHES

#304 Stainless Steel, Mill Finish

#### Optional Finishes

- POL - Polished US32, 629
- BRUSHED - Brushed US32D, 630



### OPTIONAL SIA SLIP-RESISTANT FINISH

For Use in Areas Where Conditions Can Be Hazardous and Safety is a Priority.



### OPTIONAL BUMPER SEAL

For Adhesive Mounted Silicone Bumper Seal Suffix "S"



# STAINLESS STEEL

## COVER PLATES

- ▶ PVC Coating Applied to Protect the Finish During Shipping and Installation
- ▶ Square Cut Edges Standard. Specify if Beveled Edge Is Required
- ▶ Furnished Undrilled Although Custom Drilling is Available to Your Detail
- ▶ Minimum Width 3" on 818SS and 4" on 814SS.
- ▶ #10 X 1 1/2" Stainless Steel Wood Screws Furnished

### MATERIALS & FINISHES

#304 Stainless Steel, Mill Finish

#### Optional Finishes

- POL - Polished US32, 629
- BRUSHED - Brushed US32D, 630



### OPTIONAL SIA SLIP-RESISTANT FINISH

For Use in Areas Where Conditions Can Be Hazardous and Safety is a Priority.

**Beveled Edges**  
(Available at Extra Charge)

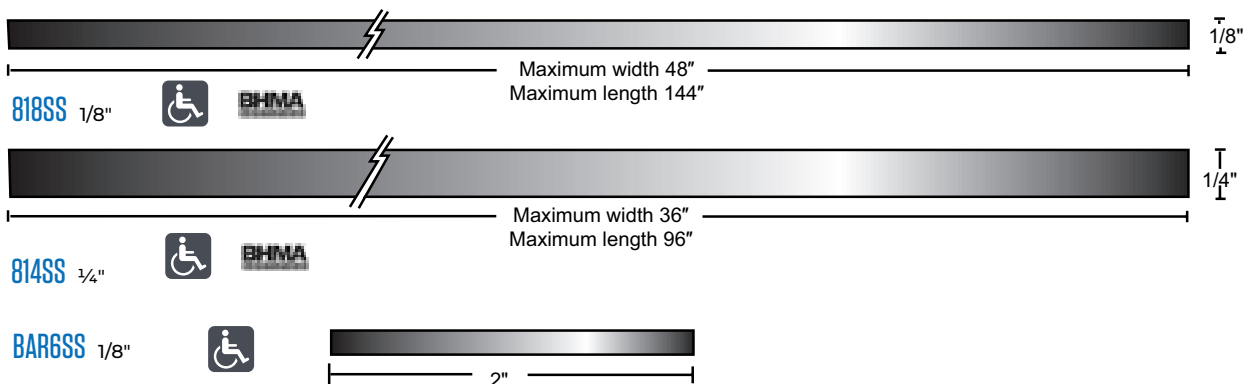

# ARCHITECTURAL BRONZE

## 1/4" SADDLE THRESHOLDS

All Products On This Page

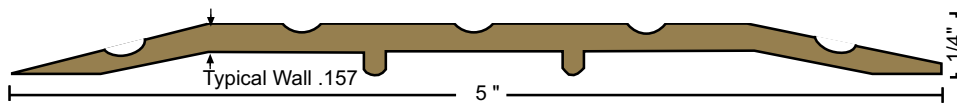

**513BR** 1.96 lbs./ft.

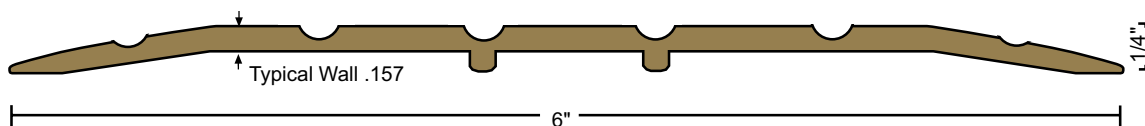

**613BR** 3.06 lbs./ft.

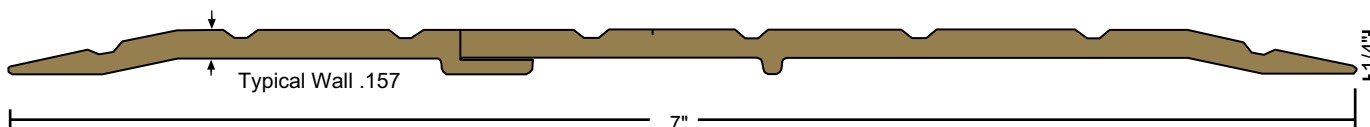

**713BR** 3.62 lbs./ft.

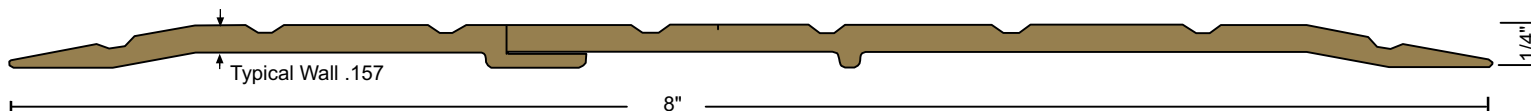

**813BR** 4.60 lbs./ft.

### MATERIALS & FINISHES

Architectural Bronze Satin Finish (728) Similar to US4

#### Optional Finishes

- POL - Polished (721)
- DKB - Dark Oxidized Oil Rubbed (722) Similar to US10B



### OPTIONAL SIA SLIP-RESISTANT FINISH

For Use in Areas Where Conditions Can Be Hazardous and Safety Is a Priority.

### FASTENERS

- #10 X 1-1/2" Solid Brass Wood Screws Furnished. Antique Bronze Finish Screws Provided With Dark Bronze Thresholds.

# ARCHITECTURAL BRONZE

## 1/2" SADDLE THRESHOLDS

All Products On This Page

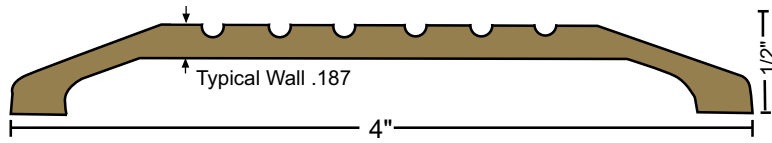

**424BR** 2.28 lbs./ft.

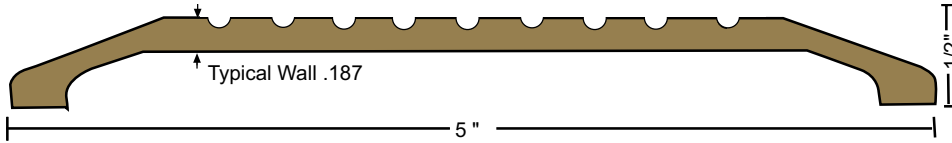

**425BR** 2.84 lbs./ft.

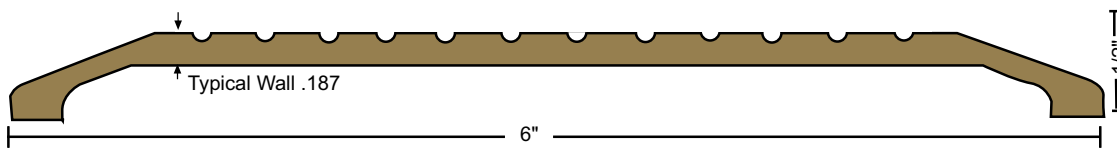

**426BR** 3.33 lbs./ft.

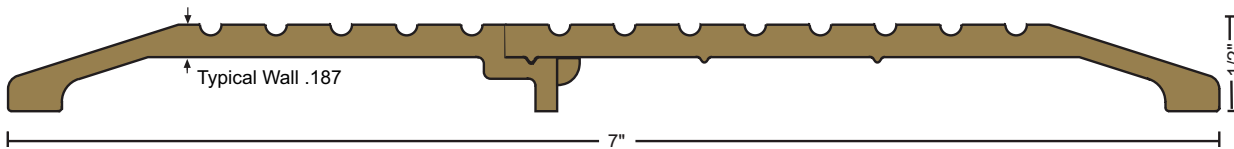

**427BR** 4.09 lbs./ft.

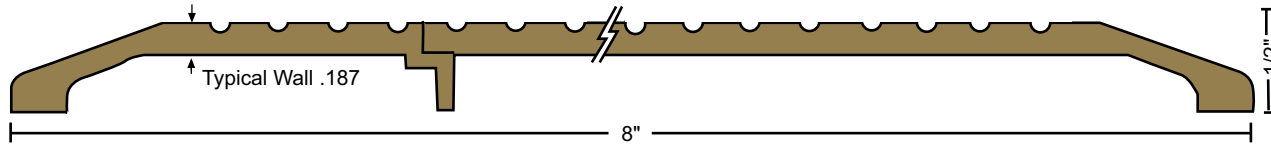

**428BR** 5.06 lbs./ft.

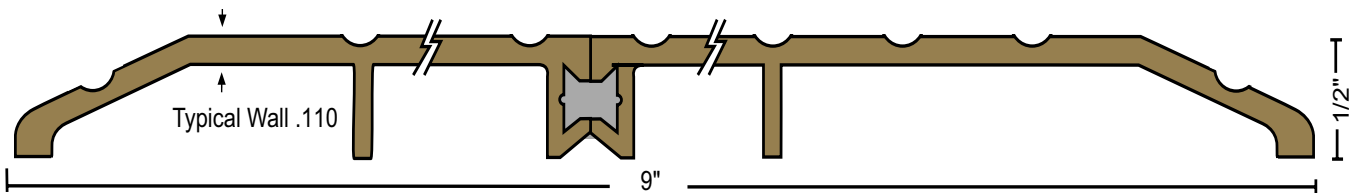

**429BR** 4.27 lbs./ft.

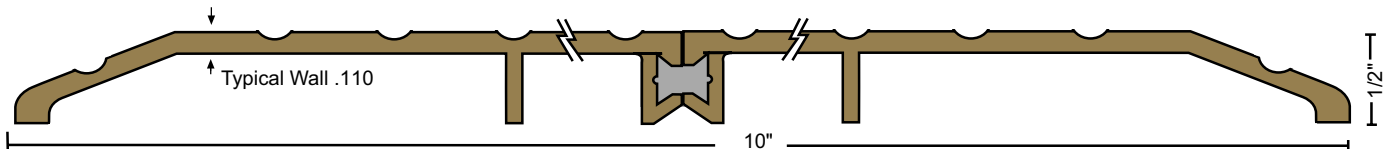

**430BR** 4.78 lbs./ft.

### MATERIALS & FINISHES

Architectural Bronze Satin Finish (728) Similar to US4

#### Optional Finishes

- POL - Polished (721)
- DKB - Dark Oxidized Oil Rubbed (722) Similar to US10B



### OPTIONAL SIA SLIP-RESISTANT FINISH

For Use in Areas Where Conditions Can Be Hazardous and Safety Is a Priority.

### FASTENERS

- #10 X 1-1/2" Solid Brass Wood Screws Furnished. Antique Bronze Finish Screws Provided With Dark Bronze Thresholds.



# ARCHITECTURAL BRONZE

## THERMAL BREAK SADDLE THRESHOLDS

All Products On This Page



Thermal Break Thresholds Feature a Rigid Thermoplastic Spline, Creating a Separation to Prevent the Transfer of Outside Temperature and Frost Through the Threshold.

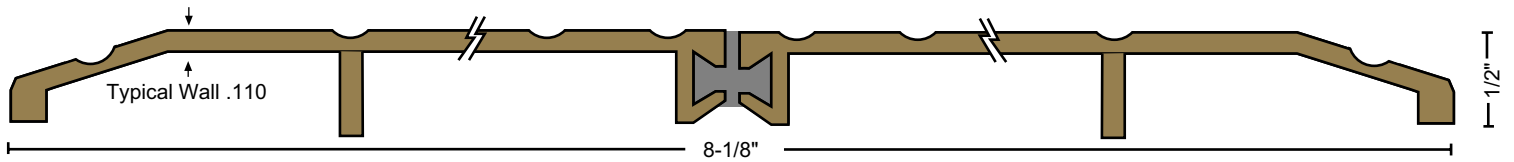

**8428BR** 3.62 lbs./ft.

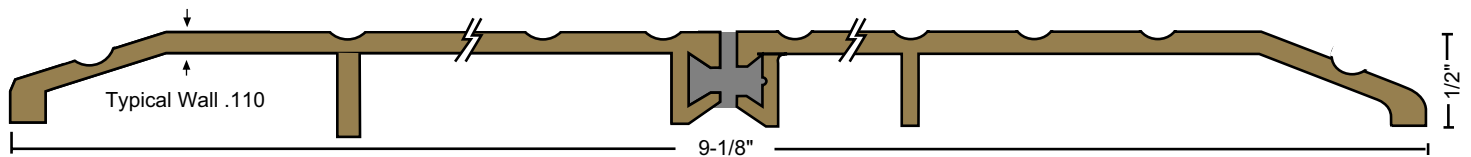

**8429BR** 4.16 lbs./ft.

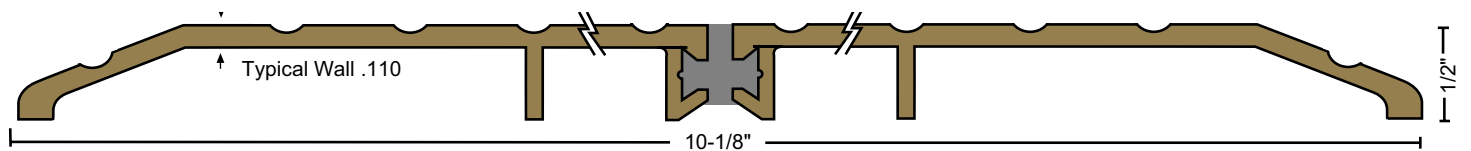

**8430BR** 4.70 lbs./ft.

### MATERIALS & FINISHES

Architectural Bronze Satin Finish (728) Similar to US4

#### Optional Finishes

- POL - Polished (721)
- DKB - Dark Oxidized Oil Rubbed (722) Similar to US10B



### OPTIONAL SIA SLIP-RESISTANT FINISH

For Use in Areas Where Conditions Can Be Hazardous and Safety Is a Priority.

### FASTENERS

- #10 X 1-1/2" Solid Brass Wood Screws Furnished. Antique Bronze Finish Screws Provided With Dark Bronze Thresholds.

# ARCHITECTURAL BRONZE

## HALF SADDLE THRESHOLDS

All Products On This Page

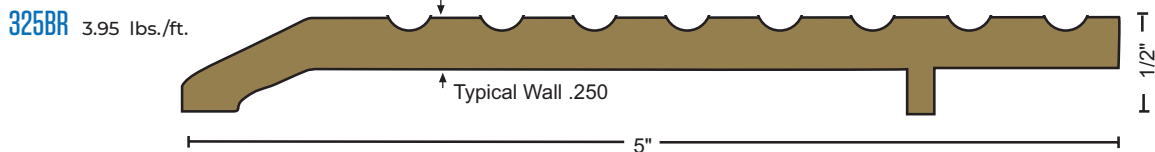
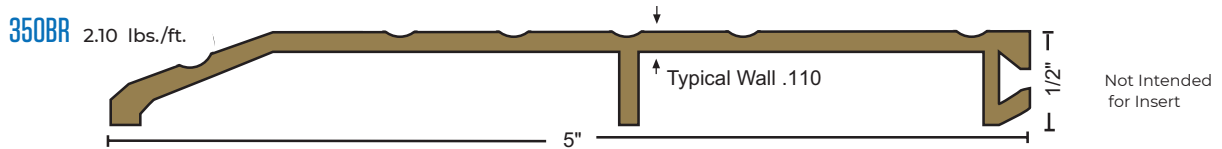
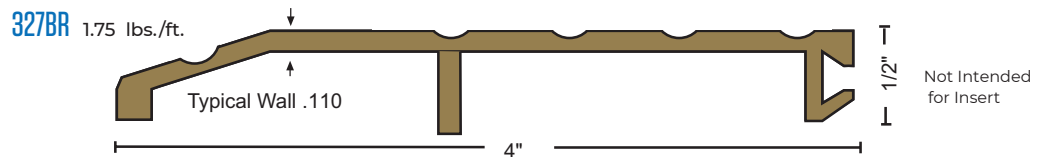
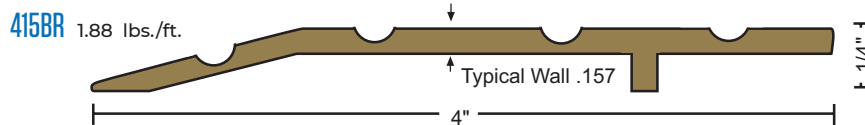
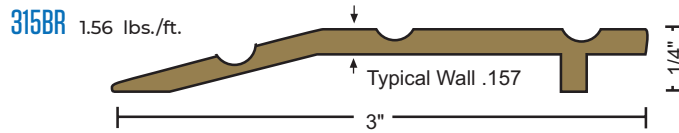

### MATERIALS & FINISHES

Architectural Bronze Satin Finish (728) Similar to US4

#### Optional Finishes

- POL - Polished (721)
- DKB - Dark Oxidized Oil Rubbed (722) Similar to US10B



### OPTIONAL SIA SLIP-RESISTANT FINISH

For Use in Areas Where Conditions Can Be Hazardous and Safety Is a Priority.

### FASTENERS

- #10 X 1 1/2" Solid Brass Wood Screws Furnished. Antique Bronze Finish Screws Provided With Dark Bronze Thresholds.



\* When Installed With the Non-Beveled Edge Flush With Flooring, or Where No Greater Than 1/4" Vertical Rise Occurs

# ARCHITECTURAL BRONZE

## INTERLOCKING THRESHOLDS

All Products On This Page

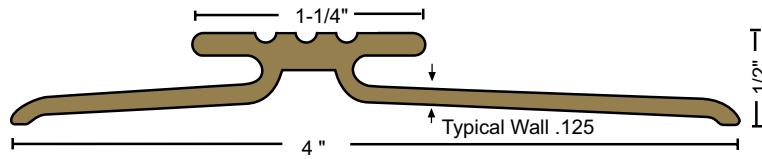

**442BR** 2.01 lbs./ft.

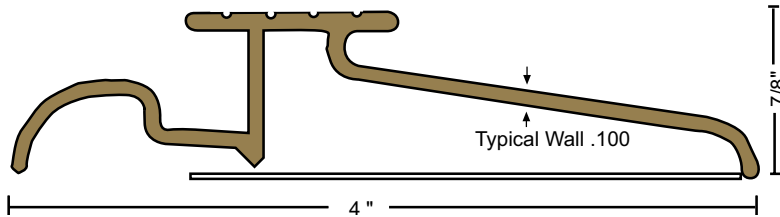

**484BR** 1.83 lbs./ft.

Weep Holes Furnished Standard.  
Bronze Pan Optional - Please Specify

**80B**

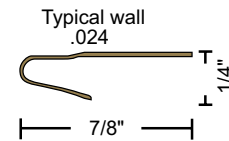

### BRONZE HOOK

Supplied Standard With Bronze Interlocking  
Thresholds: Furnished With #18 X 7/8" Nails  
**Available in 36" & 48" Lengths**

### MATERIALS & FINISHES

Architectural Bronze Satin Finish  
(728) Similar to US4

#### Optional Finishes

- POL - Polished (721)
- DKB - Dark Oxidized Oil Rubbed  
(722) Similar to US10B



### OPTIONAL SIA SLIP-RESISTANT FINISH

For Use in Areas Where  
Conditions Can Be  
Hazardous and Safety Is  
a Priority.

### FASTENERS

- #10 X 1 1/2" Solid Brass Wood  
Screws Furnished. Antique  
Bronze Finish Screws Provided  
With Dark Bronze Thresholds.

# ARCHITECTURAL BRONZE

## CUSTOM FABRICATED THRESHOLDS

All Products On This Page



Choose From Various Height and Width Components to Build Custom Thresholds to Meet Special Job Requirements. See the Custom Fabricated Threshold Example Illustrated on Page T5. For Assistance, Contact Our Tech Support Team.

Select the Proper Height Edge Components. Select the Appropriate Center Plates to Construct the Width Needed. Plates May Be Butted Together or Ripped to Make Specific Widths. Support Joints and Wider Spans With Bar Supports.

Threshold Assembly Plates May Be Used Fluted or Smooth Side Up. SIA Slip-Resistant Finish Can Be Applied to All Parts.

Threshold Assembly Components May Be Ordered Separately for Field Assembly or Welded into One-Piece Units in Our Custom Fabrication Shop. They Are Supplied Undrilled Unless a Template Is Provided. Ripping and Beveling Options Are Available. All Custom Fabricated Assemblies Have a Tolerance of +/- 1/16".

If a Welded Assembly Is Desired, Specify "Welded".

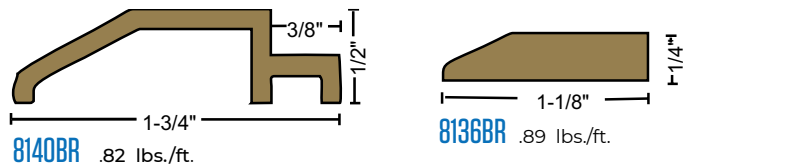

### BAR SUPPORTS

Used as Support Under Threshold Assemblies

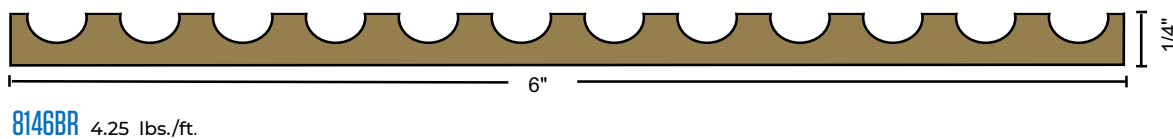
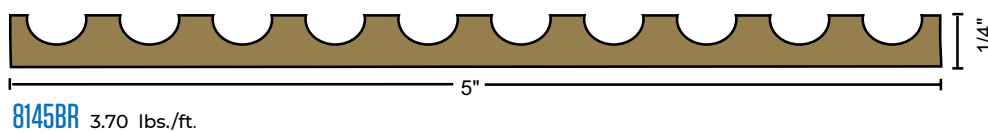
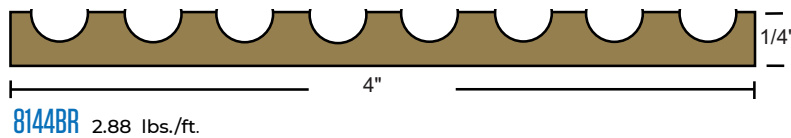
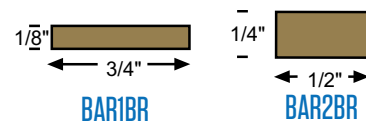

### MATERIALS & FINISHES

Architectural Bronze Satin Finish (728) Similar to US4

#### Optional Finishes

- POL - Polished (721)
- DKB - Dark Oxidized Oil Rubbed (722) Similar to US10B



### OPTIONAL SIA SLIP-RESISTANT FINISH

For Use in Areas Where Conditions Can Be Hazardous and Safety Is a Priority.

### FASTENERS

- #10 X 1-1/2" Solid Brass Wood Screws Furnished. Antique Bronze Finish Screws Provided With Dark Bronze Thresholds.

# THRESHOLD FASTENERS

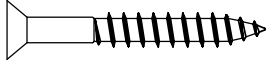

#10 x 1-1/2" Phillips Flat Head Wood Screw  
Use 1/8" Drill Bit



Phillips Head  
Top View



Spanner Head  
Top View



Torx Security  
Top View



#12 x 1-1/2" Phillips Flat Head Wood Screw  
Use 9/64" Drill Bit  
Also #12 x 1"

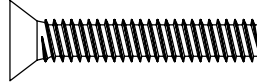

#1/4-20 x 1-1/2" Phillips Flat Head  
Machine Screw

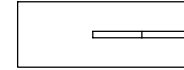

#1/4-20 Expansion Anchor  
Carbon Steel  
Use 3/8" Drill Bit

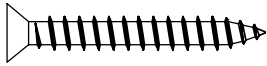

#10 x 1-1/2" Phillips Flat Head Stainless Steel  
Sheet Metal Screw  
Use 1/8" Drill Bit  
Also #10 x 1", #10 x 2", #10 x 2-12", #10 x 3"



#10-24 x 1-1/2" Phillips Flat Head  
Machine Screw  
Also #10-24 x 3/4", #10-24 x 1"



#10-24 Lead Anchor  
Use 3/8" Drill Bit and  
Powers Seating Tool

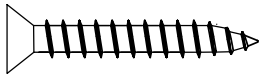

#12 x 1-1/2" Phillips Flat Head  
Sheet Metal Screw  
Use 9/64" Drill Bit  
Also: #12 x 1"

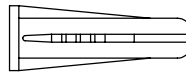

Plastic Anchor Various Sizes  
Use Drill Size = Anchor Size

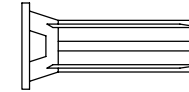

Lead Expansion Shield  
4% Antimonial Lead  
Use 5/16" Drill Bit



#6 x 3/4" Phillips Flat Head Self-Tapping  
Machine Screw  
Use 3/32" Drill Bit

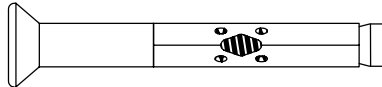

#1/4-20 Phillips Combo Flat Head Machine  
Screw/Anchor  
Use 1/4" Drill Bit

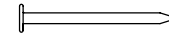

#18 X 7/8" Nail for Use With 80B  
Hook Strip

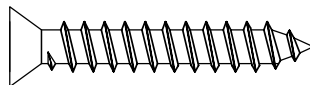

Hilti Kwik-Con II 1/4" x 1-3/4" Screw,  
Available With Phillips Head or Torx Head.  
Use Hilti TKC Large Concrete Bit SDS 1/4"  
Tough Carbide

# NOTES

---

# NOTES

---



For the most up-to-date  
Seals: Thresholds Catalog,  
scan the QR code  
or visit [ngp.com](http://ngp.com).



**[ngp.com](http://ngp.com)**  
**1-800-NGP-RUSH**

FAX: (800) 255-7874  
QUOTES: [quotes@ngp.com](mailto:quotes@ngp.com)  
ORDERS: [orders@ngp.com](mailto:orders@ngp.com)

**NGP MEMPHIS**  
4985 East Raines Road  
Memphis, TN 38118

**CARSON CITY**  
3689 Arrowhead Drive  
Carson City, NV 89706