



# HEALTHCARE

SOLUTIONS





# HEALTHCARE SOLUTIONS

## SAFE AND SOUND

WHEN IT COMES TO YOUR ORGANIZATION,  
PATIENT CARE IS NUMBER ONE.

Your choice of door hardware should compliment this mission and that is exactly what NGP's Healthcare Solutions are designed to do. From Continuous Stainless Steel Hinges, to Lite Kits and Louvers to Fire Door Accessories and Hermetically Sealed Mini Blinds, we've got a full portfolio of products that will enhance patient comfort, privacy and safety, while saving you and your staff valuable time and money.



An abundance of options to keep the sound out and the patient room quiet.



Materials that are easy to clean, longer lasting with less maintenance.



A full line-up of Fire Door Accessories to get your doors compliant.



The right products to help create a safer facility.



A certified solution stamped to keep follow-up inspections streamlined.



Our door hardware is ready for whatever your specific applications require.



Lite Kits, Louvers and Hermetically Sealed Mini Blinds create a more comfortable patient experience.

# STAINLESS STEEL CONTINUOUS HINGES

Stainless Steel Continuous Hinges Offer You the Durability, Corrosion Resistance and Finished Look You Need for Healthcare Applications.

## FEATURES

- ◆ UL Certified for use on Fire-Rated Doors
- ◆ ANSI/BHMA A156.26 Grade 1 Certified to 2,500,000 Cycles

**SS300**

Stainless Steel  
Continuous Hinge  
Concealed Mount



**SS311**

Stainless Steel  
Continuous Hinge  
Swing Clear Half Wrap  
Edge Guard



**SS315**

Stainless Steel  
Continuous Hinge  
Concealed Half Wrap  
Edge Guard



TPE SMOKE AND DRAFT CONTROL  
**SELF-ADHESIVE GASKETING**

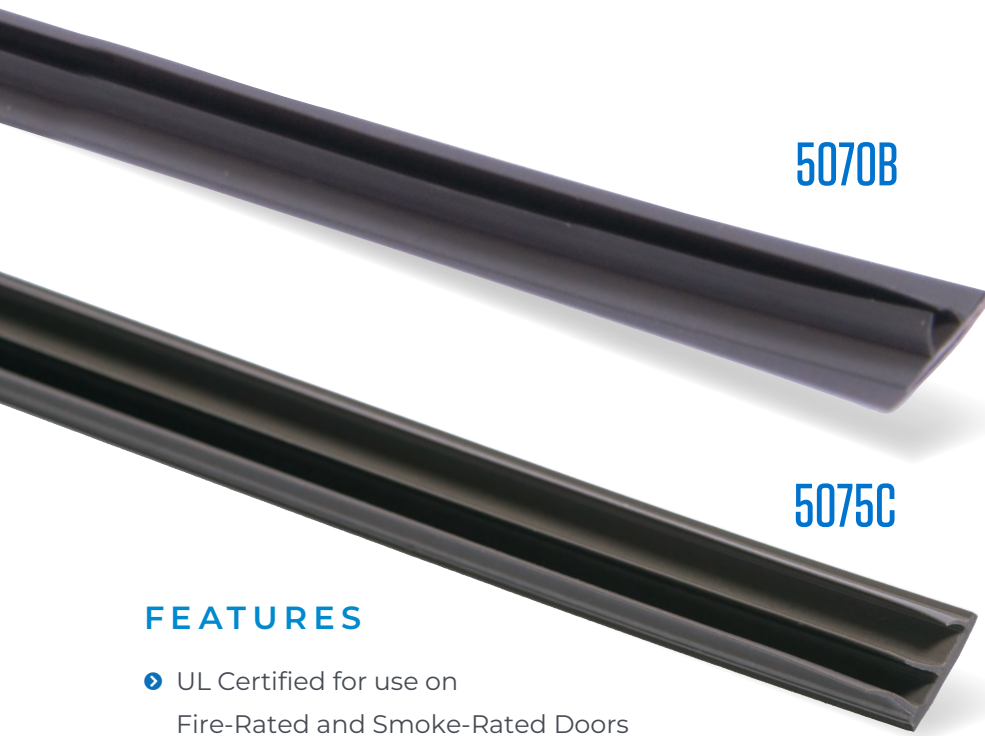

**5070B**

**5075C**

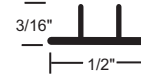

**5070B BROWN**

**5070GL CLEAR**

*Smoke rated for perimeter and/or meeting edge astragal applications*

**FEATURES**

- ▶ UL Certified for use on Fire-Rated and Smoke-Rated Doors
- ▶ Reduces Sound Penetration
- ▶ Blocks Out Light (Except Clear)

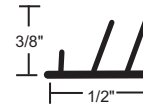

**5075C CHARCOAL**

**5075GL CLEAR**



**SILICONE PERIMETER SEALS**



**137SA**

**FEATURES**

- ▶ UL Certified for use on Fire-Rated and Smoke-Rated Doors
- ▶ Anodized Aluminum
- ▶ Reduces Sound Penetration
- ▶ Blocks Out Light

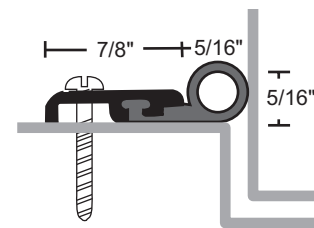

# SMOKE AND DRAFT CONTROL DOOR BOTTOM SEALS

UL Certified for use on Fire-Rated and Smoke-Rated Doors.

## Stainless Steel Door Sweep

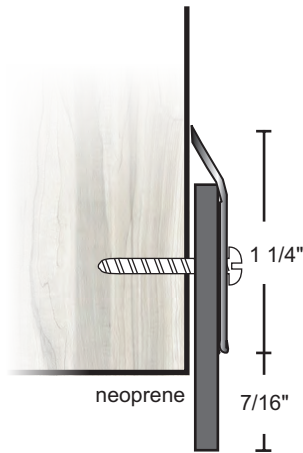

200NSS	NEOPRENE
200SSS	SILICONE

## Stainless Steel Automatic Door Bottom

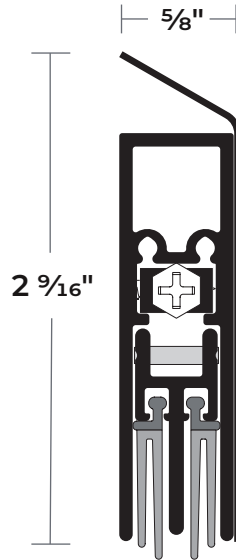

229NSS	NEOPRENE <sup>1</sup>
229SSS	SILICONE <sup>1</sup>
229WHSS	NYLON BRUSH

<sup>1</sup> Lead insert available for radiation shield - specify "lead-lined"

PRODUCT#	SUFFIX	FINISH
A		Anodized Aluminum
DKB		Dark Bronze / Black Anodized
SS		Stainless Steel

*Neoprene and Silicone are Black*

## Neoprene Sweep

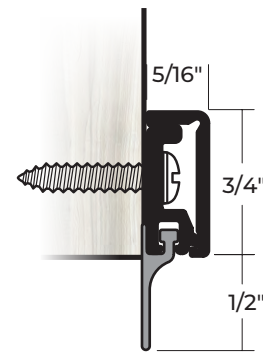

672NA	NEOPRENE
672NDKB	NEOPRENE

229SS





UL CERTIFIED FOR USE IN  
THE US AND CANADA



**GAP90**  
Fire Door  
Head/Jamb  
Gap Solution

- ▶ 1/8" - 3/8" Gaps on 60 & 90 Minute Doors
- ▶ 1/8" - 9/16" Gaps on 20 & 45 Minute Doors
- ▶ Non-Handed
- ▶ In-Field Modifiable
- ▶ Available in Dark Brown and Gray



**GAP90N**  
Fire Door Head/  
Jamb Gap Solution  
for Narrow Stops

- ▶ 1/8" - 3/8" Gaps on 60 & 90 Minute Doors
- ▶ 1/8" - 9/16" Gaps on 20 & 45 Minute Doors
- ▶ For Use When the Soffit Depth is Between 1/2" and 1 3/8"
- ▶ Non-Handed
- ▶ In-Field Modifiable
- ▶ Available in Dark Brown and Gray



**GAP90-ME**  
Fire Door Meeting  
Edge Gap Solution

- ▶ Application Certified for Fire Doors and Frames with Excessive Clearance up to 3/8"
- ▶ Non-Handed
- ▶ In-Field Modifiable
- ▶ Gray Finish



**9990**  
Fire Door Top  
Gap Solution

- ▶ Door Top Gaps, up to 1/2"
- ▶ Non-Handed
- ▶ In-Field Modifiable
- ▶ Recommended for Doors with Parallel Arm Closers
- ▶ Brushed Stainless Steel Finish



UL CERTIFIED FOR USE IN  
THE US AND CANADA



## 9590

Fire Door Bottom  
Gap Solution

- ▶ Door Bottom Gaps, up to 1½"
- ▶ Non-Handed
- ▶ In-Field Modifiable
- ▶ Brushed Stainless Steel Finish



## 9595DKB

Floating Fire Door  
Bottom Gap Solution

- ▶ Door Bottom Gaps, up to 1¾"
- ▶ Non-Handed
- ▶ Designed to Travel Over Uneven Floors,  
With a Range of ¾"
- ▶ Optional L-Bracket Allows for Easy Installation
- ▶ Powder-Coated Matte-Black

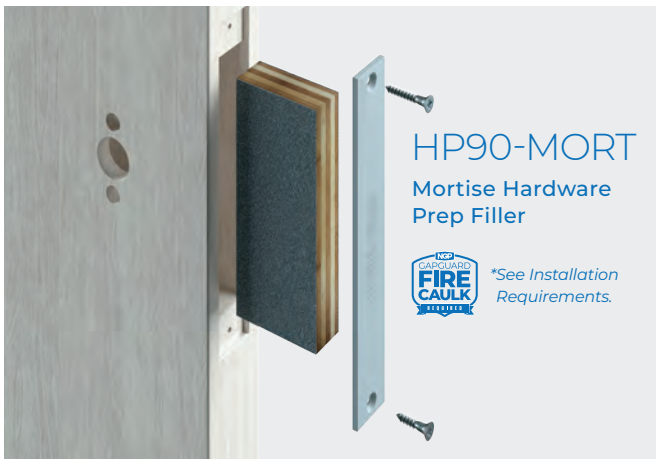

## HP90-MORT

Mortise Hardware  
Prep Filler



\*See Installation  
Requirements.



## HP90-CYL

Cylindrical Hardware  
Prep Filler



\*See Installation  
Requirements.

Includes Steel Filler  
Plates for use on Hollow  
Metal Doors



## HP90-FB

Flush Bolt  
Hardware  
Prep Filler



\*See Installation  
Requirements.

## GAPGUARD FIRE CAULK

- ▶ Fill up to a ½" Diameter Thru-Hole on 60 & 90 Minute Doors
- ▶ Fill up to a 1" Diameter Thru-Hole on 20 & 45 Minute Doors
- ▶ Fully-Cured in 24 Hours
- ▶ Sandable/Paintable
- ▶ Color: Tan
- ▶ 10.0 oz Cartridges, 10 per box
- ▶ 3.0 oz. Tubes, 6 Tubes per Box



\*To retain UL Certification,  
the products indicated  
must be installed using  
GapGuard Fire Caulk.

## 90-Minute Fire Door STRIKE SHIMS

- ▶ 60 and 90 Minute Fire Doors with Gaps Over  $\frac{1}{8}$ ", up to  $\frac{3}{8}$ "
- ▶ 20 and 45 Minute Fire Doors with Gaps Over  $\frac{1}{8}$ ", up to  $\frac{9}{16}$ "
- ▶ 9275 - Fits  $4\frac{7}{8}$ " 'ASA' Strike Plate
- ▶ 9225 - Fits  $2\frac{3}{4}$ " 'T' Strike Plate
- ▶ Required for Proper Latchbolt Engagement

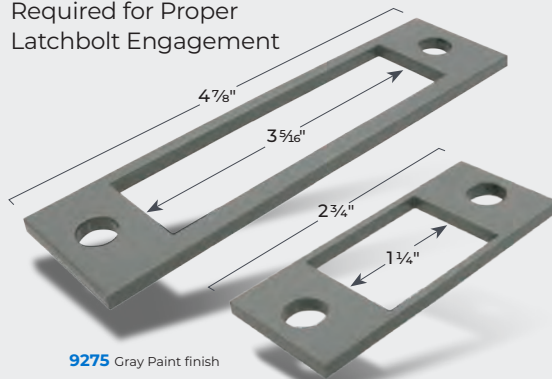

## GAP90/GAP90N END CAPS

- ▶ For Use on GAP90 and GAP90N Steel Stop Extender Components
- ▶ Sold in 10 packs



## 90-Minute Fire Door STEEL HINGE SHIMS

- ▶ Use to Shim Hinges to Achieve Required Clearances Between Door and Frame
- ▶ Use Full 42" Length for Continuous Hinges
- ▶ Break-Off  $3\frac{1}{2}$ " Sections for Butt Hinges
- ▶ Pressure Sensitive Adhesive Pads Included for Holding in Place During Installation
- ▶ Available in Boxes of Ten



## 90-Minute Fire Door THRU-BOLTS

- ▶ Fits  $1\frac{3}{4}$ " to 2" Thick Doors
- ▶ Zinc-Plated Steel Sleeve with Machine Screws
- ▶ Meets Requirements of NFPA 80 for Use on Fire Doors
- ▶ Use to Fill Holes in Wood or Steel Fire Doors to Protect Label Compliance
- ▶ Available in Boxes of Twenty

HEAVY-DUTY

# SLIDING DOOR HARDWARE

Stainless Steel

## BARN DOOR HARDWARE

- ▶ Brushed Stainless Steel 304
- ▶ Nylon Coated Stainless Steel Wheels for Smooth Operation
- ▶ Max Weight Load 220 lbs.
- ▶ ANSI/BHMA A156.14 Grade 1 Certified to 100,000 Cycles
- ▶ 5-Year Warranty
- ▶ Order Two Sets for Bi-parting Applications

### SLSS1

Stainless Steel  
Top Mount  
Round Track  
System



### SLSS2

Stainless Steel  
Side Mount  
Round Track  
System



Aluminum

## SIDE WALL MOUNT SLIDING DOOR HARDWARE

- ▶ Max Weight Load 250 lbs.
- ▶ ANSI/BHMA A156.14 Grade 1 Certified to 100,000 Cycles
- ▶ Optional Soft Close
- ▶ Optional Snap-On Fascias (SL-RD and SL-SQ18)
- ▶ 5-Year Warranty



### SLAL-250-SW

Aluminum Side Wall  
Mount Track System

# HEAVY-DUTY SADDLE THRESHOLDS

Heavy-Duty Thresholds Built For High-Traffic  
Forklift And Vehicular Areas.

## FEATURES

- ANSI/BHMA A156.21 Certified to 10,000 lb. Load Test
- UL Certified for use on Fire-Rated Doors
- Available in "SIA" Slip-Resistant Finish

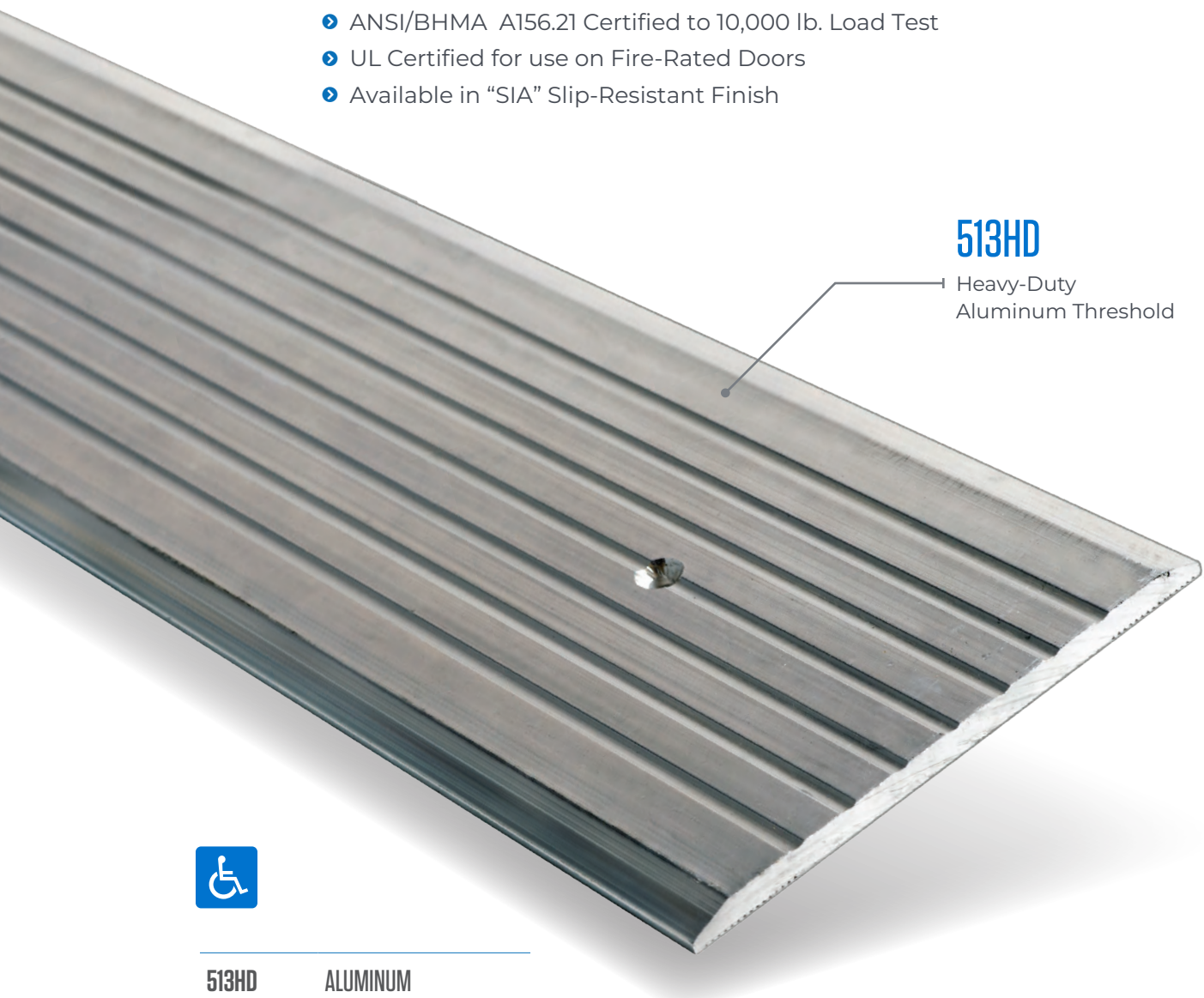

**513HD**

Heavy-Duty  
Aluminum Threshold



513HD	ALUMINUM
513HDDKB	DARK BRONZE

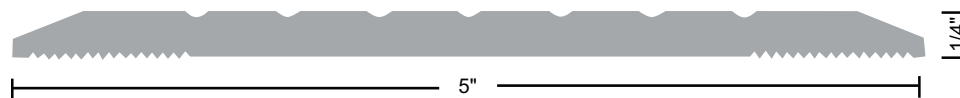

# STAINLESS STEEL COVER PLATES

## 818SS

Stainless Steel Cover Plate, 1/8"



- ▶ UL Certified for use on Fire-Rated Doors
- ▶ Width: 3" (min.)–48" (max.). Maximum Length 144"
- ▶ Available with a Beveled Edge
- ▶ Optional Slip Resistant SIA Finish Suffix "SIA"

## 513SS

Stainless Steel Saddle Threshold, 1/4" x 5"

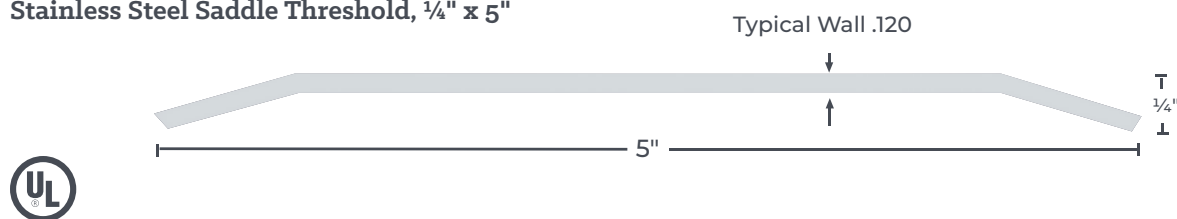

# STAINLESS STEEL DOOR EDGES AND ASTRAGALS

## 555SS

Parallel Bevel Astragal for  
Double Egress Doors

- ▶ UL Certified for use on  
Fire-Rated Doors

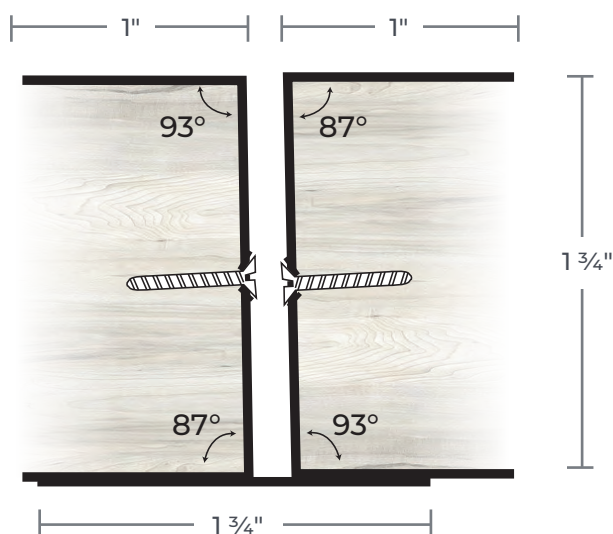

# LOW PROFILE LITE KIT

Designed for 1 3/4" Thick Doors  
And 3/16", 1/4" or 5/16" Glass

## L-FRA100

- ▶ 18-Gauge, Cold Rolled Steel
- ▶ UL Certified for use on Fire-Rated Doors
- ▶ Powder Coat Finishes:
  - Gray Primer (GPZ)
  - Dark Bronze (DKB)
  - Tan (T)

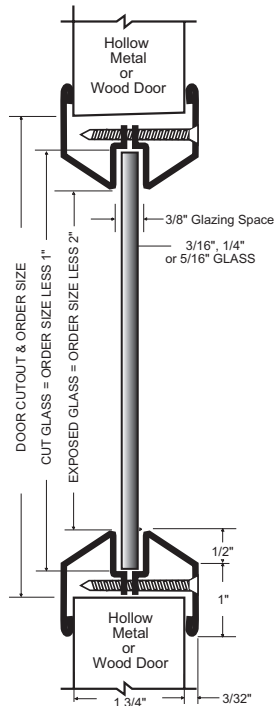

## FIRE-PROTECTIVE SAFETY GLASS CERAMIC

# PYRAN® PLATINUM F

Fire-Rated 3/16" Glass

## FEATURES

- ▶ UL Certified to ANSI/UL9, ANSI/UL10B, ANSI/UL10C, CAN/ULC-S104, ULC CAN4-S106

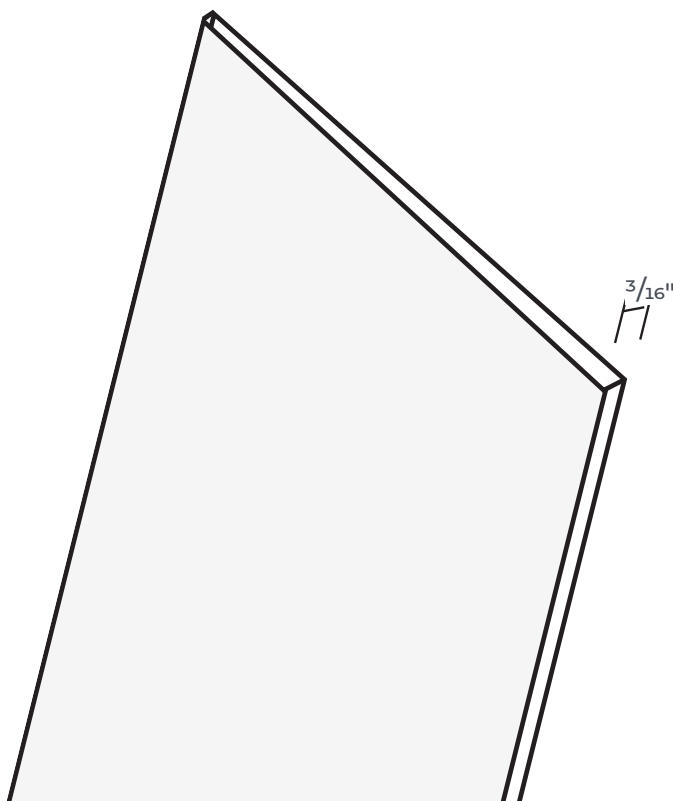

LITE KIT AND LOUVERS

# NO VISION DOOR LOUVER

Designed for 1 3/4" Thick Doors

## L-700-RX

### FEATURES

- 18-Gauge, Cold Rolled Steel
- Mitered and Welded Corners
- Powder Coat Finishes:
  - Gray Primer (GPZ)
  - Dark Bronze (DKB)
  - Tan (T)

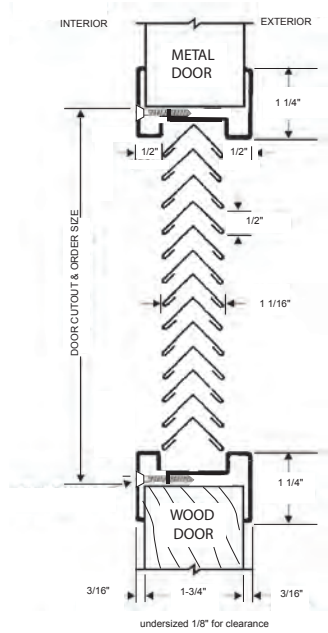

LITE KIT AND LOUVERS

# FIRE-RATED FUSIBLE LINK LOUVER

Designed for 1 3/4" Thick Doors

## L-1900

### FEATURES

- Blades Close when Activated by Fire/Heat
- 18-Gauge, Cold Rolled Steel Frame
- UL Certified for use on Fire-Rated Doors up to 90 Minutes
- Minimum Size: 10" X 6"
- Maximum Size: 24" X 30"

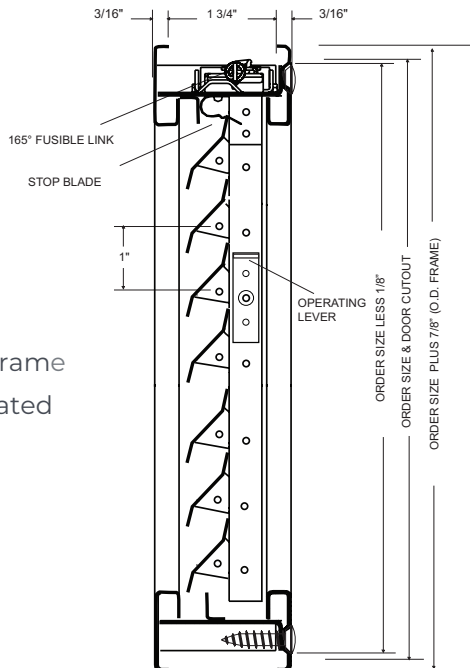

*Undersized 1/8" for clearance*



## GLASS WITH INTEGRATED MINI BLINDS



### L-MINI BLINDS 1" IGU

**Mini Blind Insulated Glass Units are for Lite Kit and Borrowed Lite Applications.**

#### FEATURES

- Commercial Grade Hermetically Sealed Venetian Blind System Inside Insulating Glass Unit – 1" Thick
- Interior or Exterior Applications
- Clear Tempered Safety Glass Both Sides
- Magnetic Slider, Placed on the Right or Left-Hand Side of the Glass for Tilting, Lowering and Raising Functions
- Minimum Width 8 5/8", Maximum Width 35 3/4"
- Minimum Height 14", Maximum Height 80"
- Fits Low Profile L-FRA100-SP Lite Kit
- Standard Blind Color is White
- Orders for this Product are Non-Changeable and Non-Cancellable

*Special features and glass types available to meet specification requirements.*

#### GLASS

## X-RAY SAFETY LEAD GLASS

#### FEATURES

- Thickness = 5/16" to 5/8"
- Lead Equivalency = 1/16" to 3/16"

5/16" – 5/8" 



# HEALTHCARE SOLUTIONS

FOR MORE INFORMATION,  
CALL US OR VISIT:

**ngp.com**  
1-800-NGP-RUSH



**ngp.com**  
**1-800-NGP-RUSH**

FAX: (800) 255-7874  
QUOTES: quotes@ngp.com

**NGP MEMPHIS**  
4985 East Raines Road  
Memphis, TN 38118  
orders@ngp.com

**NGP VEGAS**  
4584 Calimesa Street  
Las Vegas, NV 89115  
vegasorders@ngp.com